

UNCLASSIFIED

*Cy 322108*

15 December 1958

*ABMA*  
Report No. D-TN-1-59

**ARMY**

# BALLISTIC MISSILE AGENC

REDSTONE ARSENAL, ALABAMA

*ABMA-D-TN-1-59*

DOWNGRADED AT 3 YEARS AFTER DATE OF DECLASSIFICATION  
DECLASSIFIED AT 30 YEARS  
DOD DIS

*cy 3*

ABMA PRESENTATION

to the

NASA (U)

*RS93-0381*

*C AA 59752*

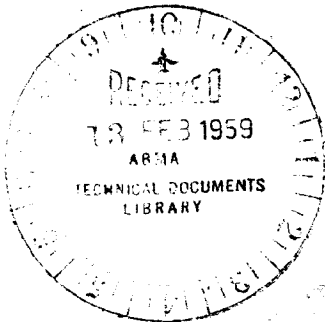

REDSTONE SCIENTIFIC INFORMATION CENTER



5 0510 00057091 8

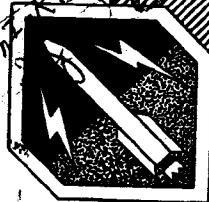

**DEVELOPMENT OPERATIONS  
DIVISION**

UNCLASSIFIED

UNCLASSIFIED

UNCLASSIFIED

"The material contained in this report has been published for information and possible use by other Government activities. It represents the results of work performed at the Army Ballistic Missile Agency and records a significant mark of achievement of the organization or individual whose name appears hereon. This report is NOT intended to indicate that the material contained herein has been fully evaluated, tested and accepted by this Agency or the degree to which it has been or may be used in accomplishment of the Agency mission."

UNCLASSIFIED

UNCLASSIFIED

**SECURITY NOTE**

*This document contains information affecting the national defense of the United States within the meaning of the Espionage Law, Title 18, U.S.C., Section 793 and 794, as amended. The transmission or revelation of its contents in any manner to an unauthorized person is prohibited by law.*

UNCLASSIFIED

UNCLASSIFIED

~~SECRET~~  
FOREWORD

At the request of the National Aeronautics and Space Administration, ABMA and AFBMD made presentations on vehicular programs for the national space flight program at NASA Headquarters in Washington, D. C., 15 December 1958.

The ABMA presentation was broken down into four parts as follows:

Present and Future Vehicles and Their Capabilities	Dr. W. von Braun
Vehicle-Mission Compatibility and System Integration	Mr. H. H. Koelle
ABMA Contributions in the Area of Earth-Launched Vehicles	Dr. W. von Braun
Vehicle Components and Research Objectives	Dr. E. Stuhlinger

This publication documents the ABMA presentation. The text was prepared from the stenotype copy of the proceedings. Replicas of the charts have been inserted in the text at the point of first reference. A limited number of NASA reports which document the complete proceedings will be available in the near future.

UNCLASSIFIED

## ROSTER

Ayres, L. F., Col, AFBMD  
Bleymaier, T. S., Col, AFBMD  
Boushey, H. A., Brig Gen, Hq, USAF  
Canright, R. B., ARPA/DOD  
Cole, Charles W., JPL  
Dennen, R. L., Maj, AFBMD  
Dick, W. W., Maj Gen, Army R&D  
Donovan, A. F., STL  
Dryden, Hugh L., NASA  
Ely, Lawrence D., Col, AFBMD  
Finger, Harold B., NASA  
Glennan, T. K., NASA  
Goodfellow, A. S., Cdr, BuOrd, USN  
Greer, R. B., Brig Gen, Hq, USAF  
Hall, E. W., NASA  
Heaton, D. H., Col, Hq, USAF  
Hodgson, A. S., NASA  
Hyatt, A., NASA  
Huber, William G., ABMA  
Kleis, C. Fred, 1st Lt, ABMA  
Koelle, Herman H., ABMA  
Lawrence, William H., AFBMD  
Longfelder, H. J., ARPA/DOD  
Marshall, F. G., Capt, CNO/USN  
McKee, Daniel D., ARDC  
McKenney, J. D., JPL  
Mitchell, Elliot, NASA  
Meill, T. T., NASA  
Newell, Homer E., Jr., NASA  
Phillips, F. W., NASA  
Pickering, W. H., JPL  
Rosen, Milton W., NASA  
Rothrock, A. M., NASA  
Sanders, N. D., NASA  
Siepert, Albert F., NASA  
Silverstein, A., NASA  
Snodgrass, Richard B., NASA  
Stewart, H. J., NASA  
Stuhlinger, Ernst, ABMA  
Thomas, R. G., Col, ARPA  
Tischler, A. O., NASA  
von Braun, W., ABMA  
Walters, J. W., Lt Col, Army R&D  
Weigand, H., Hq, USAF AFOAT

## LIST OF CHARTS

Chart		Page
1	U. S. Space Activities	6
2	U. S. Space Research Activities	7
3	Commercial Space Flight	8
4	U. S. Space Carrier Vehicles and Systems	9
5	Overall Dimensions of U. S. Space Carrier Vehicles	13
6	Overall Dimensions of Future U. S. Space Carrier Vehicles	14
7	Expected Maximum U. S. Orbital Payload Capabilities Vs. Time	16
8	Expected Maximum U. S. Lunar Flight Payload Capabilities Vs. Time	18
9	Velocity Requirements for Typical Space Missions	20
10	Growth Factor of Some U. S. Space Vehicles for Typical Missions	22
11	Estimates Payload Vs. Altitude	24
12	Typical Military Requirements Large Rocket Vehicles	32
13	Typical U. S. Large Rocket Vehicle Firing Rate	33
14	Anticipated Milestones of a Typical U. S. Space Flight Effort	36
15	Typical Orbital Research Program	38
16	Typical Man-in-Space Program	40
17	Typical Cislunar and Lunar Research Program	41
18	Typical Interplanetary, Planetary and Solar Research Program	44
19	U. S. Space Research	45

LIST OF CHARTS (Continued)

Chart		Page
20	Typical NASA Vehicle Requirements and Firing Plan	47
21	Typical Integrated NASA Mission and Firing Plan	49
22	Typical Vehicle Purchasing Schedule	50
23	Assumptions for Vehicle Cost Per Firing	51
24	Expected Expenditure for Vehicles for Typical Integrated Space Research Program	52
25	Total Expected Vehicle Expenditures	53
26	Items Not Covered in Cost Estimates	56
27	Accumulated Payload Weights	57
28	Cost Per Pound Payload Trend Vs. Time for Typical Missions	59
29	JUNO V Booster	65
30	Air-Transportable Booster JUNO V	68
31	JUNO V F1-H1 Combination	71
32	Use of JUNO V Booster as Test Bed for 1.5 Million Pound Single Barrel Engine	72
33	JUNO V Family Tree 1st Generation (1960-1970)	73
34	JUNO V Vehicle Standard First Generation	76
35	Preliminary Estimates of JUNO V Payload Capability for Selected Space Missions	77
36	Orbital Return Vehicle (16-Man Carrier)	79
37	16-Man Carrier (Orbital Return Vehicle)	80
38	Cross Section Main Assembly Building	82
39	Floor Plan Main Assembly Building 4705	83
40	Thrust Frame Assembly and Alignment Fixture	84

LIST OF CHARTS (Continued)

Chart		Page
41	Main Cluster Final Assembly Fixture Phase I	85
42	Main Cluster Final Assembly Fixture Phase II	87
43	Main Cluster Final Assembly Fixture Phase III	88
44	Main Cluster Final Assembly Fixture Phase IV	89
45	ABMA Static Test Tower (View 1)	91
46	ABMA Static Test Tower (View 2)	92
47	JUNO V Booster Transportation	95
48	Route Modification (Fabrication Building to River Dock)	96
49	Recommended JUNO V (AMR) Launching Site	97
50	Launching Table	99
51	Erection Assembly Phase I	100
52	Erection Assembly Phase II	101
53	Erection Assembly Phase III	102
54	Parachute Recovery of JUNO V Booster	104
55	Total Project Cost for Parachute Recovery Plotted Vs. Rejuvenation Factor With Booster Recovery Probability as a Parameter	106
56	Typical JUNO V Schedule and Mission Chart (1)	108
57	Proposed Typical JUNO V Schedule and Mission Chart (2)	109
58	Trajectory Scheme 1	114
59	Vehicle Family for Lunar Expedition	116
60	Trajectory Scheme 2	117
61	Trajectory Scheme 3	119
62	Trajectory Scheme 4	121



LIST OF CHARTS (Concluded)

Chart		Page
63	Trajectory Scheme 5	123
64	Highlights of Space Program	130
65	Satellites for Research and Component Development	131
66	Space Technologies I	132
67	Space Technologies II	133
68	Space Technologies III	134
69	Test Objectives (Vertical Probes)	141
70	Test Objectives (Small Satellites)	142
71	Test Objectives (Medium Satellites)	143
72	Test Objectives (Large Satellites)	144
73	Lunar Exploration	147



OPENING COMMENTS AND INTRODUCTION

DR. SILVERSTEIN: The lead-off here for the presentation will be by the Army Ballistics Missile Agency.

I think, von Braun, you are leading off the group?

DR. VON BRAUN: Yes.

DR. SILVERSTEIN: And so I call on you to make your presentation.

DR. VON BRAUN: I hope after Abe's introduction, the real task ahead of us won't disappoint you, because I am afraid that after the previous presentation our approach will be a little bit on the conservative side.

We hope to break down <sup>our</sup> ~~out~~ two-hour presentation into four different talks of about 30 minutes each. The first two talks will be given by myself and Mr. Koelle, Chief of our Future Projects Design Branch. His group serves as a kind of stage-laying group for what follows.

It is my intention to first present to you a breakdown on the present and future vehicle program on the national scale as it has been presented by the various agencies in the field with the idea in mind of giving an over-all review on where we really stand in the vehicle field.

Now, this includes practically everything in this business and I hope that when we give facts and figures on other vehicle programs, we have quoted the right sources. At any rate, we have tried to do our best.

I will then try to extrapolate to give an idea of what, in our opinion, logical future programs will be like.

After I am through with the general breakdown, Mr. Koelle will tie in with my presentation and give a presentation on what a representative over-all space program may look like. By this, I mean, how the elements of the various space programs -- such as the man-in-space program or the orbital rendezvous capability, cargo capability, and so forth -- must dove-tail with such programs as, say, putting a man on the moon.

The third talk I will also give, and it will specifically deal with our so-called JUNO V booster, which is a clustered 1.5-million-pound



[REDACTED]

thrust booster, presently being developed by ABMA under ARPA contract. Mr. Koelle's talk will already have shown how this booster would fit into the over-all national program.

At the end of my second presentation, Dr. Stuhlinger will give a talk on research objectives, bringing in the question of what component development must be carried out in the space environment itself.

The idea is that without knowing what kind of payloads one needs, it is not possible to intelligently discuss the requirements for a vehicle program.

We also feel that there are certain tests that require the space environment as a testing laboratory, and we feel that special satellites should be made available to test such things as solar or nuclear power plants for space vehicles - say, planetary probes - because it would be foolish in our opinion to fire, for example, a planetary probe to Mars without first testing the power plant in the actual space environment. The power plant should be placed in an orbit around the earth where it can be monitored for a couple of months to see how well it behaves. We feel that this also is an essential part of the over-all program.

Without much further ado, let me go into my first presentation.

PRESENT AND FUTURE VEHICLES AND THEIR CAPABILITIES

By

Dr. Wernher von Braun



## PRESENT AND FUTURE VEHICLES AND THEIR CAPABILITIES

This first chart (Chart 1) gives an over-all breakdown of the space activities in the United States. These are broken down into military and civilian requirements. Military requirements are determined by the Department of Defense, and can be broken down as strategic space weapons, such as ICBM's and IRBM's, reconnaissance satellites, et cetera; and the space defense system, anything to do with protecting the country from "space spying" or even from aggressive satellite and other space systems.

The other portion, the civilian end of it, can be roughly broken down into a scientific portion, that is, space research, and hopefully into some future commercial application, such as space flight with business in mind.

The space research activities on which we want to concentrate today are shown here (Chart 2): orbital research, man in space, lunar research, planetary and interplanetary research, and solar research. These should be self-explanatory.

This is the hopeful portion of it (Chart 3): we hope one finds that from 1965 on, there will be a real commercial interest by companies such as Bell Telephone in such applications as communication satellites for communications TV, and global mail service. Interest will also probably be shown in a permanent manned orbital transportation system, because we feel there will be lots of research work in progress - some of it using space stations perhaps, and reliable transportation systems will be required to get back and forth. Then from the year 2,000 on, we could start mining the moon, or something like that. Other commercial satellites may be desirable for things we may not even know of today - navigational purposes, and the like. And, then, we anticipate lunar transportation a little bit ahead of the planetary transportation.

This chart (Chart 4) gives a breakdown of the presently suggested, contemplated, or, in some cases, activated vehicle programs. We have

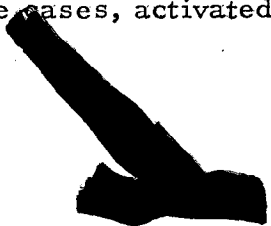

9

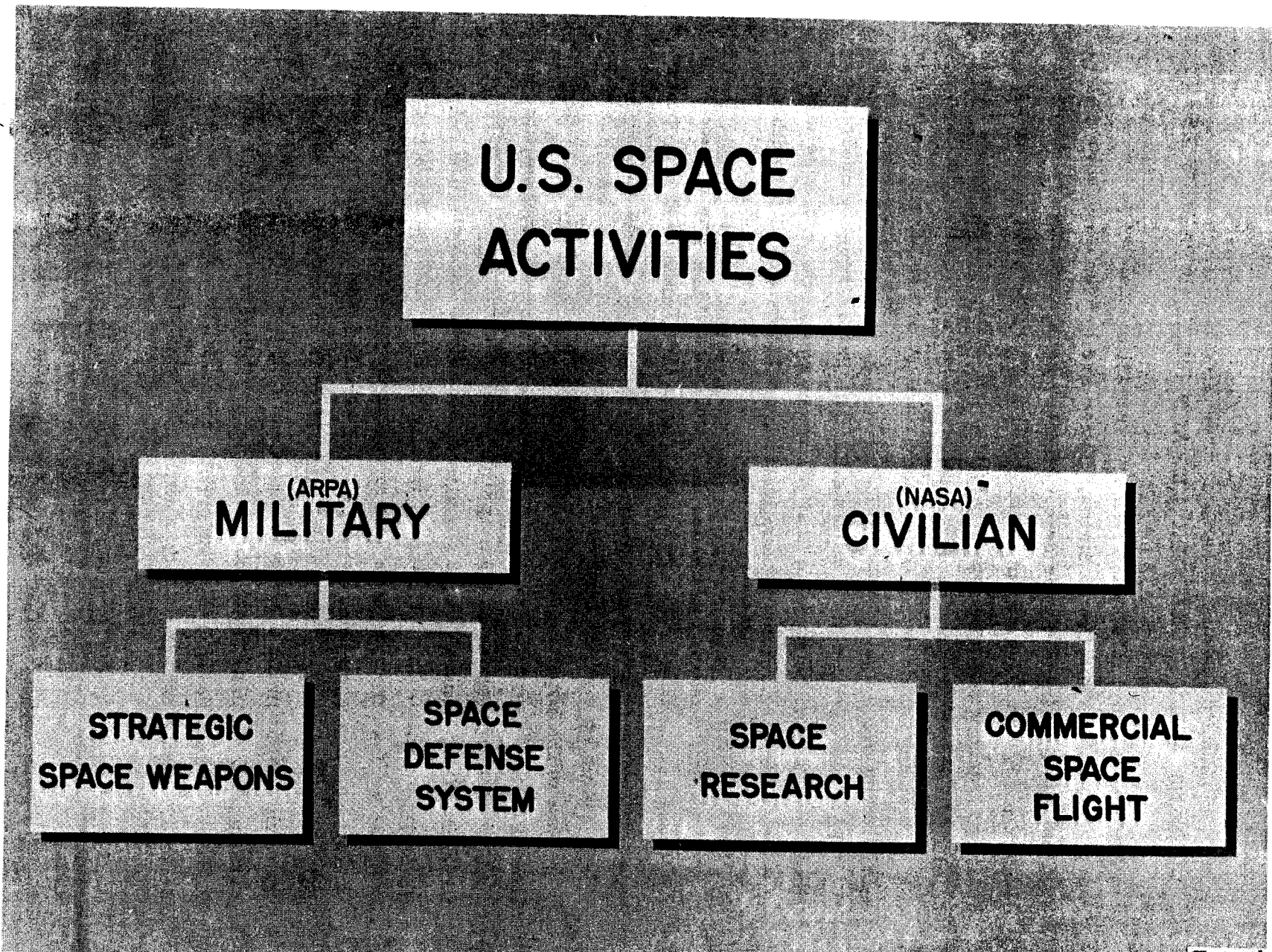

Chart 1

# U.S. SPACE RESEARCH ACTIVITIES

**ORBITAL  
RESEARCH**

**MAN  
IN  
SPACE**

**LUNAR  
RESEARCH**

**PLANETARY  
AND INTER-  
PLANETARY  
RESEARCH**

**SOLAR  
RESEARCH**

8

# COMMERCIAL SPACE FLIGHT

COMMUNICATION  
SATELLITE

1965 →

PERMANENT  
MANNED ORBITAL  
TRANSPORTATION  
SYSTEM

1970 →

PLANETARY  
TRANSPORTATION

2000 →

OTHER  
COMMERCIAL  
SATELLITES

1968 →

LUNAR  
TRANSPORTATION

1980 →

Chart 3

FILE NO. 691-3 8 DEC 68



# U.S. SPACE CARRIER VEHICLES AND SYSTEMS

CLASS	NAME	ORBITAL PAYLOAD RANGE	EXP. PERIOD OF OPERATION
I	JUNO I VANGUARD SCOUT	} 10-100 LB.	1958
			1957 / 59
			1960 / 65
II	JUNO II THOR-ABLE SENTRY / THOR NOMAD / THOR (JUPITER)	} 100-1000 LB.	1958 / 60
			1958 / 59
			1958 / 60
			1960 / 65
III	SENTRY / ATLAS SUPER-ATLAS TITAN FAMILY	} 1,000-10,000 LB.	1960 / 62
			1961 / 64
			1963 ?
IV	JUNO IV (STANDARD) (HIGH ENERGY) (NUCLEAR ENERGY)	} 10,000-30,000 LB. 30,000-50,000 LB. 50,000-100,000 LB.	1961 / 65
			1964 / 70
			1968 ?
V	6,000 K BOOSTER PLUS CHEM. OR NUCLEAR UPPER STAGES	100,000- 1,000,000 LB.	1968 ?
VI	NUCLEAR FISSION PROPULSION SYSTEM AND VEHICLE	> 1,000,000 LB.	1980 ?

[REDACTED]

broken them down into six classes, each class representing a certain broad payload category.

In the first class are the JUNO I, or the Explorer-type vehicle; the VANGUARD; and the newly activated NASA SCOUT, which is a four-stage solid rocket vehicle with a payload capability approaching the performance of the second carrier class.

In the second category, which is based essentially on IRBM carriers in the first stage, there is the JUNO II, which is the JUPITER carrier. It employs the JUPITER in the first stage, with the JPL cluster in the nose. We used this vehicle in our recent attempt to get close to the moon.

Then there is the THOR-ABLE. The ABLE used the VANGUARD second stage on top of the THOR IRBM. Then, there is the SENTRY-THOR, the SENTRY being the 117L power plant. The NOMAD-THOR uses as a second stage the NOMAD, an engine development by Rocketdyne. The JUPITER could also be used in combination with the NOMAD. All these provide payload capability in the order of 100 to 1,000 pounds.

The third class will be the ICBM class, all three of these vehicles being based on the ATLAS or TITAN. The basic vehicle will be the ATLAS with the SENTRY. This vehicle will serve as the carrier for the reconnaissance satellite program.

Then there is the SUPER-ATLAS, which is an ATLAS with the Pratt and Whitney hydrogen-oxygen 30,000 pound thrust stage forming the second stage.

And, finally, there is the TITAN family. The basic TITAN vehicle is used as the first stage, and there are many possibilities for upper stages. Emphasis should be placed on the recovery of the first stage, a feature which is not offered by the ATLAS space vehicle.

The ICBM-class of space vehicles will have a nominal payload capability between 1,000 and 10,000 pounds.

I would like to mention that all of these orbital payloads refer to an orbit of 306 nautical miles, or a 96-minute orbit which is convenient

[REDACTED]

to use for definition purposes to be exact. The upper limit of 10,000 pounds in the orbital payload range (see Chart 4) refers to the SUPER-ATLAS, for instance, using the hydrogen and oxygen second stage, and the 1,000 pounds is the rock bottom payload capability one may reach using only the unmodified TITAN.

Class IV is the next generation type vehicle; and, of course, we hope that this will be the JUNO V. The JUNO V will serve as the basic booster for this generation.

The JUNO V is our proposal for a 1.5-million-pound-thrust booster, utilizing eight existing 150,000 pound engines which, however, for that purpose, and at that time will be operated at 188,000 pounds. This program is well under way at Rocketdyne.

The JUNO V, very much like the ATLASES or the IRBM's, would first come with standard upper stages, which means that JP fuels and lox would power the upper stages. With standard upper stages, the JUNO V has a payload capability of 20,000 to 30,000 pounds.

Then, there is a high-energy chemical fuel combination conceivable. For example, if you want to go all out, the Pratt and Whitney top-stage 30,000-pound thrust could serve as a third stage, and the second stage could be developed in accordance with a North American proposal for either a 225,000 or 450,000 pound thrust hydrogen-oxygen stage. They propose to use the pumps that they have developed in connection with the nuclear hydrogen reactor motor known as the ROVER program. With these stages riding on top of the JUNO V, the payload capability would be up to 50,000 pounds. The figure of 30,000 pounds (Chart 4) would apply if only the third stage is hydrogen and oxygen and the second stage remains JP/lox.

Finally, there is a possibility of putting a nuclear energy top stage on the JUNO V, thus building a two-stage vehicle with a chemical booster and a nuclear reactor on top.

Assuming a KIWI-B type of reactor with a 750,000 pound thrust level as a second stage, we would hopefully attain payload capabilities of 100,000 pounds. This is based on, I believe, using 850 specific impulse for this engine.

[REDACTED]

I would like to mention that 20,000 pounds or so must be allowed in this case for shielding in the top stage, if one would want to carry personnel in the top stage; whereas, for a cargo carrier, the shielding could possibly be omitted.

It would appear the next desirable step after the JUNO V would be the 6,000K, or 6 million-pound-thrust booster, which could use four of the 1.5 million pound thrust single-barrel engines which were recently taken into development.

We believe that the 1.5 million pound single-barrel engines would be the logical next step because, by just looking back at the past record in engine development, it is pretty obvious that such an engine could not be flight certified prior to anything like three to five years and at that time we will not be satisfied with just duplicating a thrust level we already have.

By clustering this engine into a 6 million pound thrust, or even more, we would then get into the payload categories that Abe established as a requirement. So we believe it would be the next logical step.

Ultimately -- and this carries a big question mark -- there would be the nuclear fission type rocket, using nuclear fission all the way through, where you have the full 800 specific impulse right from the beginning.

The investigations carried out by AEC indicate that nuclear engines are either attractive as top stages for chemical rockets, omitting the shielding requirement; or if you want to use them from the bottom up, the units must be very large and properly protected. So if such a program is carried out successfully, we may expect at some later date a sixth generation missile, completely nuclear, capable of orbiting a payload in the order of 1,000,000 pounds.

The next two charts (Charts 5 and 6) show the profiles of the vehicles that were just discussed. I will run through them.

Class I: JUNO I, VANGUARD, and SCOUT.

Class II: JUNO II, and here is the THOR family, with SENTRY, ABLE, and NOMAD forming the various top stages. They look similar,

SECRET

# OVERALL DIMENSIONS OF U.S. SPACE CARRIER VEHICLES

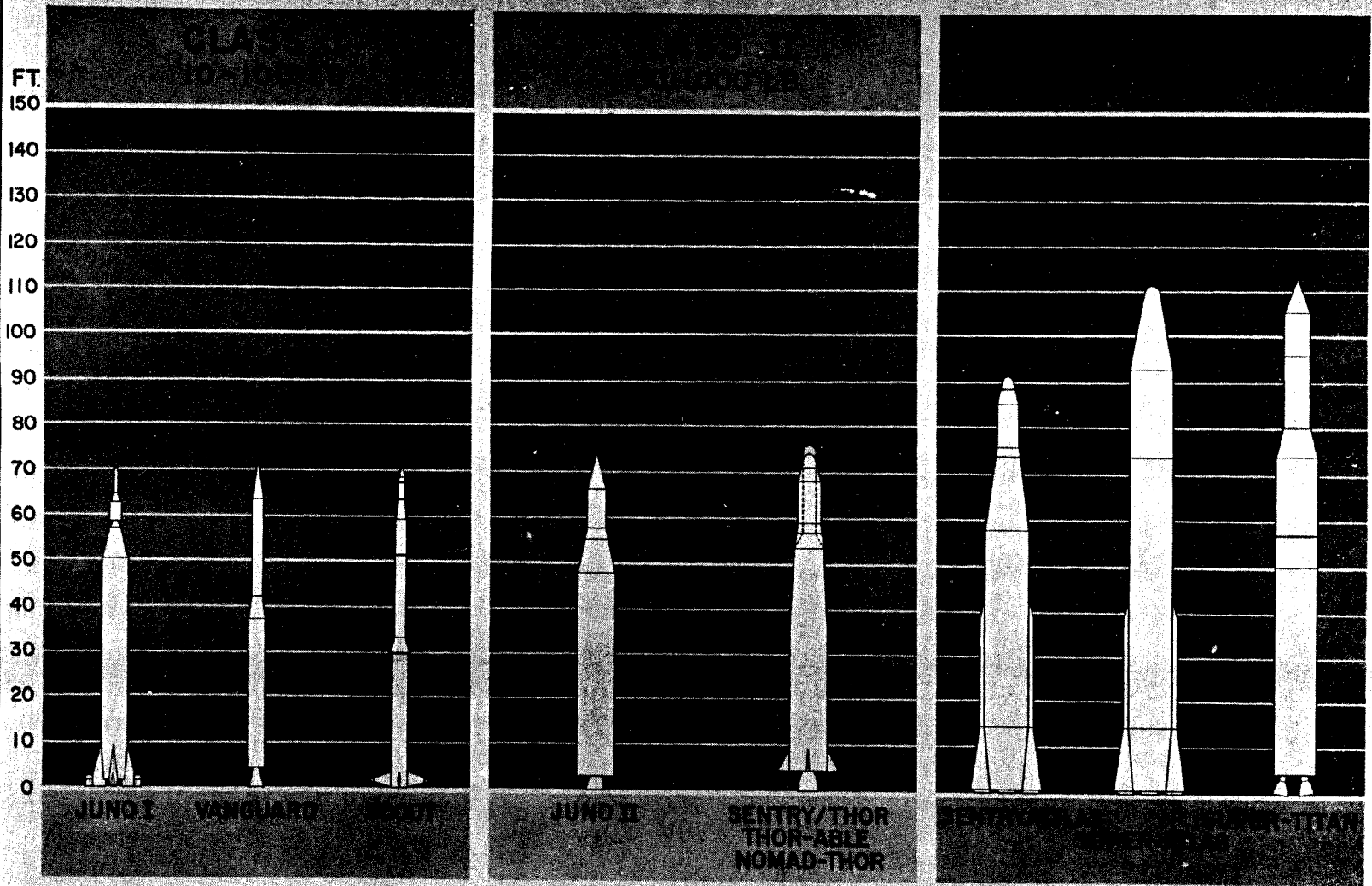

# OVERALL DIMENSIONS OF FUTURE U.S. SPACE CARRIER VEHICLES

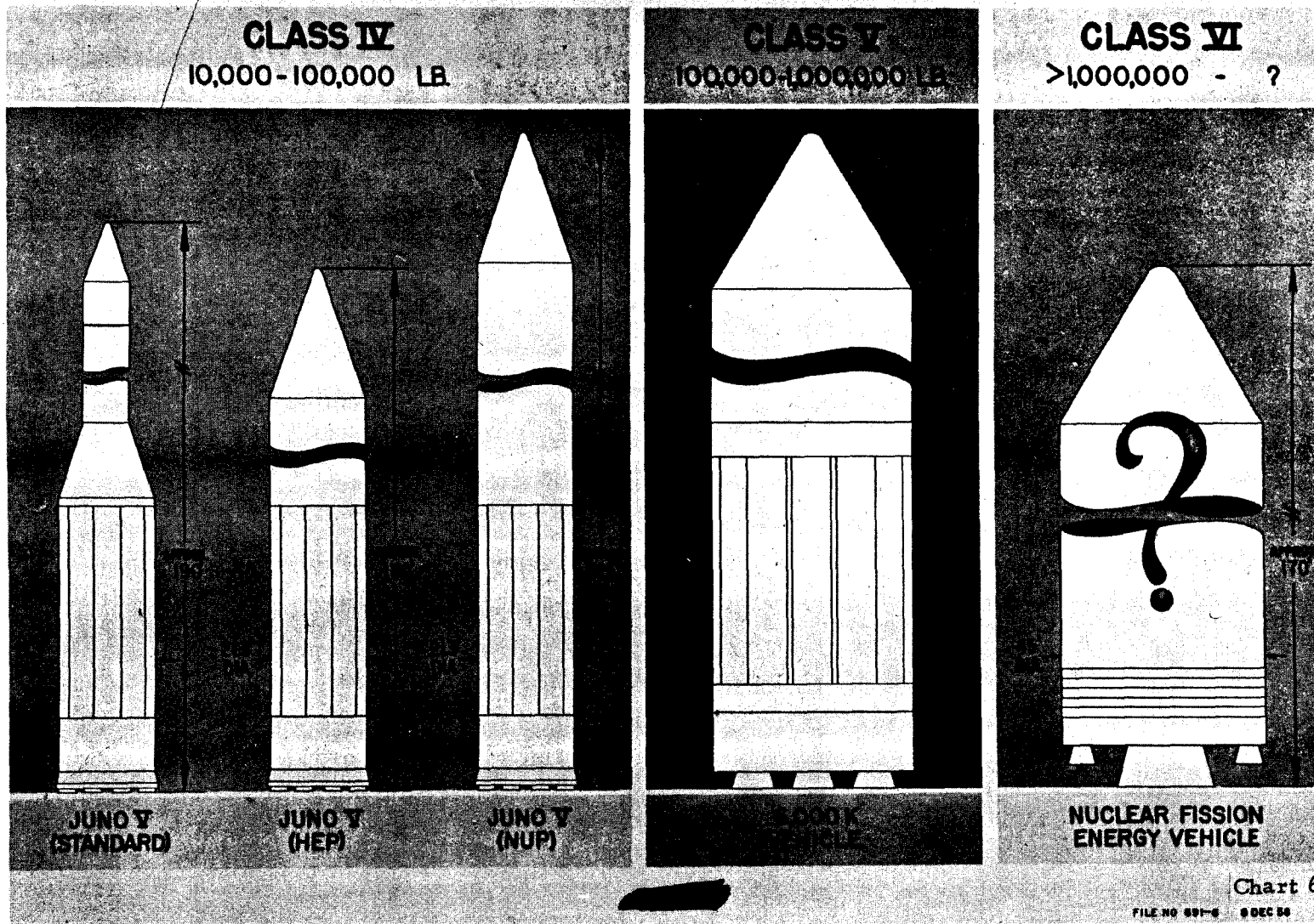

14

Chart 6

FILE NO 891-6 8 DEC 56

[REDACTED]

so we have only one drawing for all of them.

Class III would be the SENTRY-ATLAS, and the SUPER-ATLAS with the bulky hydrogen-oxygen Pratt and Whitney engine in the top stage. Also a SUPER-TITAN - whatever that is. The TITAN is the first stage (preferably recoverable), with some exotic second and third stages.

Class IV, the JUNO V family, is shown here (Chart 6) with standard chemical propellants in the first stage, with hydrogen-oxygen in the second and third stages, and finally with nuclear-propelled top stage. The latter would give us up to a 100,000 pound payload capability.

This is the Class V vehicle, which would indicate a 6 million-pound-thrust engine using the engine with 1.5 million pounds thrust per barrel, which could again have chemical or nuclear top stages. And finally Class VI, with the big question mark, would be the all-nuclear job.

This chart (Chart 7) shows an expected maximum U.S. orbital payload capability versus time. We have plotted the net payload capabilities achieved or expected during the period from 1958 to 1971. This is the logarithmic scale, beginning at 10 and going to 1,000,000 pounds net payload. Therefore, the rate of increase appears far less than it is; so remember, this is a logarithmic scale.

We have also omitted from this chart all vehicles not representing the maximum available at that particular time. For example, you will see -- and I hope this is considered as proof of our unbiased approach to this -- for example, we forgot our own JUNO II in this whole thing, conceding readily that the SENTRY-THOR, which I think was scheduled to be flown today for the first time, will up the payload capability available today to the order of 200 to 300 pounds, which we cannot match with the JUNO II at this time. So this is the maximum we consider attainable at a certain time.

The upper line refers to an equatorial 96-minute orbit, which is 306 nautical miles up.

# EXPECTED MAXIMUM U.S. ORBITAL PAYLOAD CAPABILITIES VS TIME

16

NET  
PAYLOAD  
W<sub>11,14,15</sub>  
(LB)

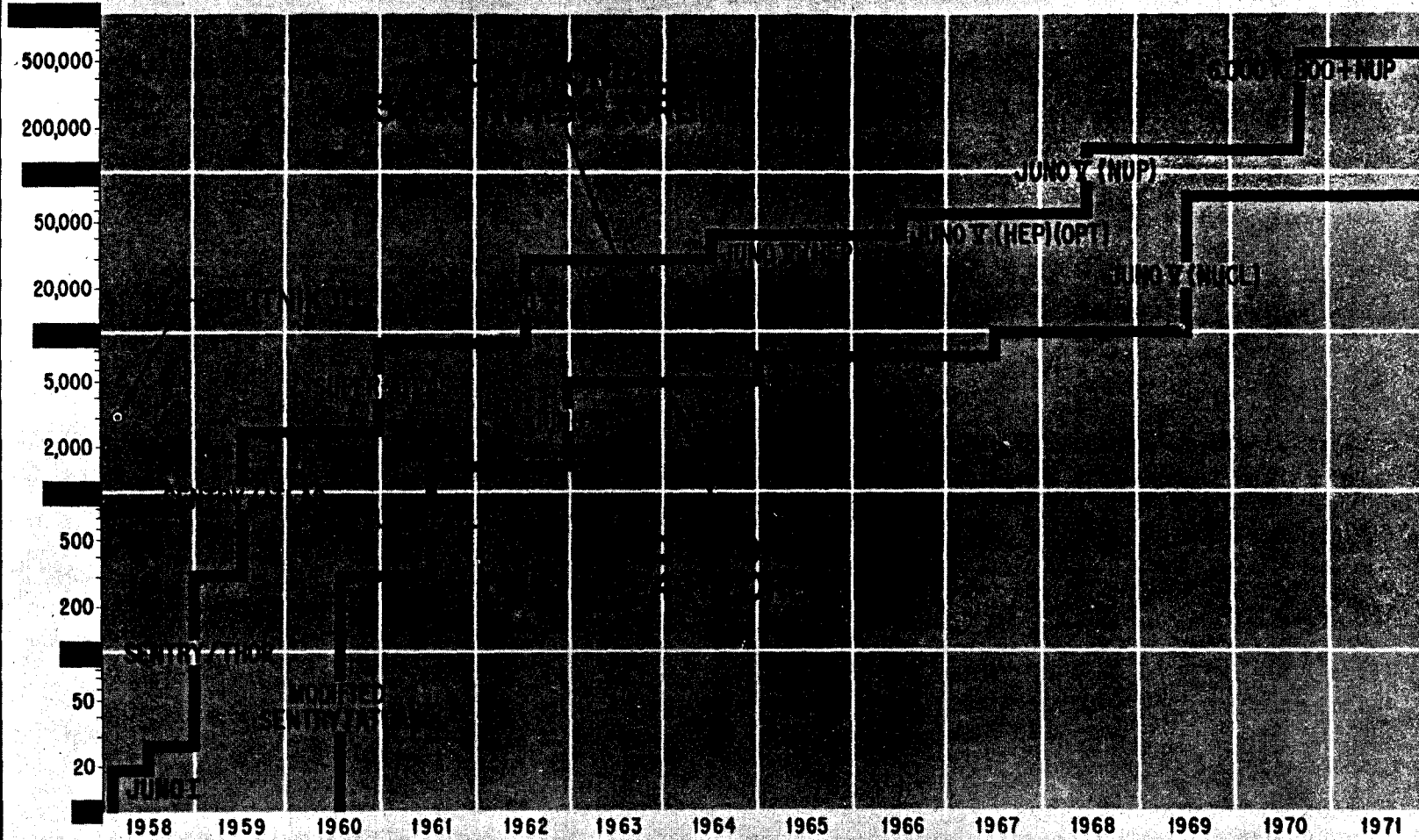

Chart 70



[REDACTED]

You see with the JUNO I's and VANGUARD in 1958, we have payloads of 20 to 30 pounds. Now, if everything goes well, it will jump up to 300 pounds today. And, then, sometime in mid-1959, we can expect a 3,000 pound capability with the SENTRY-ATLAS in orbit; and then in late 1960, maybe, an 8,000 or 9,000 pound capability depending on when the Pratt and Whitney engine becomes available and can be flown as a top stage on the ATLAS.

Then, in the summer of 1962, there is a jump to a 25,000 or 30,000 pound capability with the JUNO V.

Here again, with the high energy propellants, the payload capability would rise to 50,000 pounds, and, maybe one fine day with the nuclear engine to 100,000 or even 120,000 pounds for unmanned missions.

Finally, with the 6,000K attained by clustering four 1.5 million pound engines, you go into the 500,000-pound payload class.

Note that we feel it does not look very attractive to even try to attain an equatorial 24-hour orbit probe until about summer 1960, simply because the smaller vehicles are not capable of carrying an attractive payload into this very difficult orbit.

The controlled 24-hour orbit, as you will see on future charts, is actually more difficult to attain than escape speed and the hard landing on the moon. It is about the nastiest task that can be assigned.

Here we have the payload capabilities versus time, again in the logarithmic scale, and again plotted over the years 1958 to 1971, for lunar hard landings and lunar soft landings (Chart 8). It is based essentially on the same vehicles. It should be noted that the velocity requirements are higher in the case of soft landings; and, as a result, the payloads are less.

It is felt that, for lunar hard landings, the first really attractive payload would require something like a modified SENTRY-ATLAS. It would probably require a stage on top of the SENTRY, but, with this vehicle, you could get a lunar hard-landing capability of something like 500 to 600 pounds.

# EXPECTED MAXIMUM U.S. LUNAR FLIGHT PAYLOAD CAPABILITIES VS TIME

18  
NET  
PAYLOAD  
W11,14,15  
(LB)

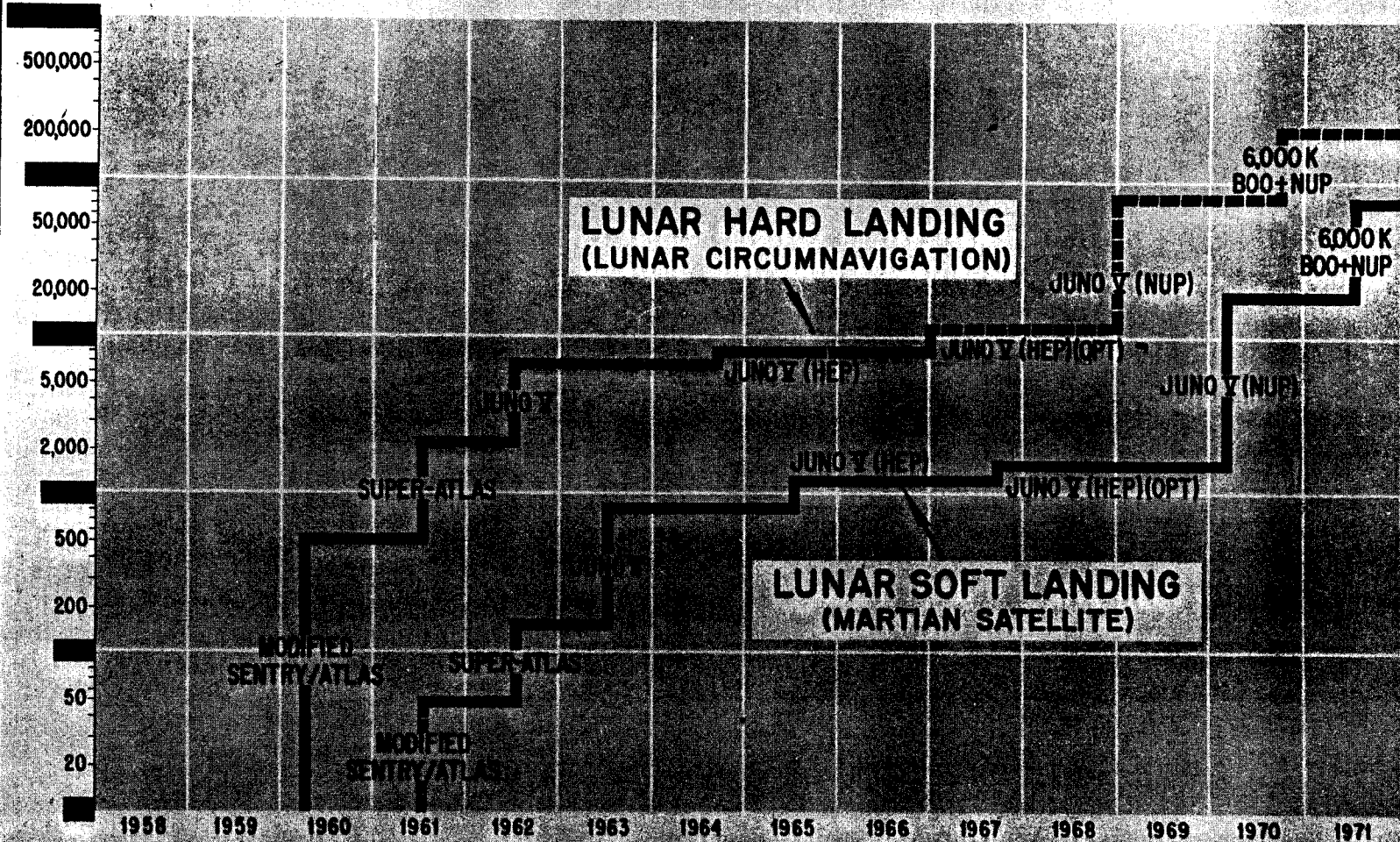

[REDACTED]

The SUPER-ATLAS ups this again; and with the JUNO V, we go up further. But from here on, the line is shown dotted because we feel there is no point in using payloads in the order of 10,000 or even 100,000 pounds for a hard landing on the moon, though lunar circumnavigation is still of interest. It would be better to convert part of that weight into soft-landing capability, so that the experiment would be more useful.

At this point then, we will switch primarily to the lunar soft-landing capability.

There is only a very marginal capability with the modified SENTRY-ATLAS as shown by the dotted line. About 50 pounds is all that could be expected for a soft landing. But, with the SUPER-ATLAS, and particularly with the JUNO V, things become interesting: we get pretty close to a 1,000 pound soft-landing capability. With the JUNO V nuclear top stage, this soft-landing payload would go up to about 20,000 pounds; and with the 6,000K cluster, of course, still higher.

It is interesting to note that the velocity requirements for lunar hard landing, and for lunar circumnavigation, are approximately alike, and that the velocity requirements for a lunar soft landing are approximately the same as for a Martian satellite. I am speaking only of the velocity requirements here. There are, of course, some tricky navigational problems involved as you go into the planet world.

This chart (Chart 9) shows velocity requirements in general. You see this broken down into the various requirements: escape, 24-hour orbit, and so forth. You see that the 24-hour orbit requires 13 kilometers per second; whereas, escape is only about 12.5 kilometers per second. So the 24-hour orbit is a pretty nasty thing and is practically the same as lunar circumnavigation and return.

Interplanetary probes and lunar satellites fall into the same category, and only when you go into the things like the lunar soft landing or Martian satellite do you up this to 16 kilometers per second.

Then comes solar system escape, another interesting thing, requiring 18.5 kilometers per second. It is also very interesting to

# VELOCITY REQUIREMENTS FOR TYPICAL SPACE MISSIONS

(Km/Sec)

20

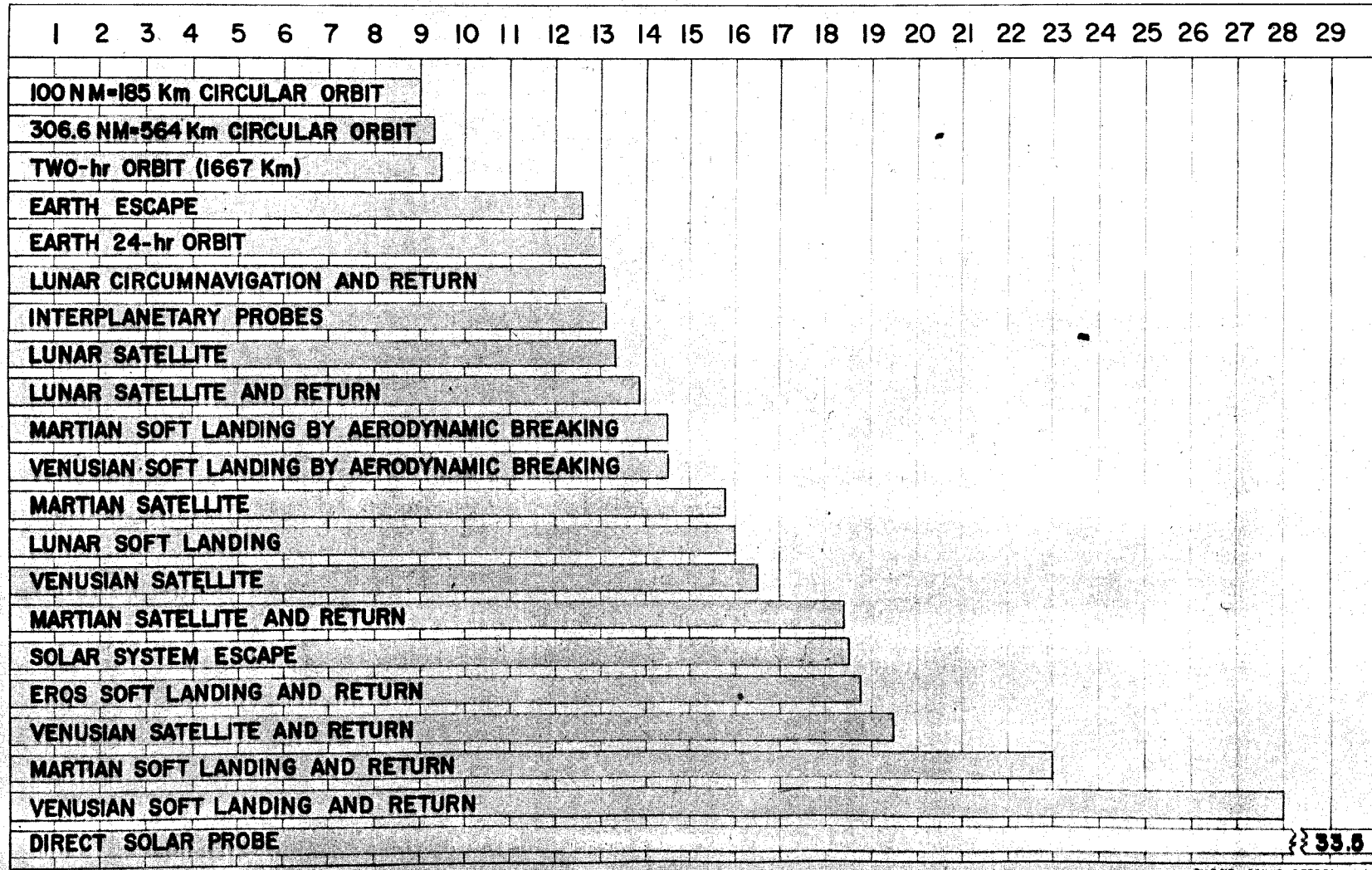

Chart 9

FILE NO. 691-10 8 DEC 56

[REDACTED]

note that the direct solar probe, if you want to go the shortest possible way, requires a velocity up to 33.5 kilometers per second.

This is due to the fact that in order to run something directly into the sun, you have to compensate for the entire orbital velocity of the earth. The vehicle would have to be fired opposite to the earth's orbital motion around the sun. All other probes will go into elliptical transfer orbits. Of course, you can approach the sun with much less velocity if you settle for Mercury, or the like; but if you really want to run it directly into the sun, the energy requirement is the greatest of all of them.

This chart (Chart 10) shows growth factors (M) of some U. S. space vehicles for typical missions. We mean the ratio between gross weight to net payload. In other words, how much weight is required per pound payload-in-orbit, escape, 24-hour orbit, and lunar soft landing.

For example, with the JUNO I, it was necessary to launch initially 2,520 pounds per pound in orbit. All this information is referring normally to a circular orbit of 306 nautical mile altitude.

With the VANGUARD, the figure is better, this being a more idealized three-stage vehicle. The staging is better; the specific impulses are higher.

The JUNO II is approximately the same as the VANGUARD. I think the lower VANGUARD figure (500) refers to the 70-pound payload that the advanced VANGUARD will hopefully try for in 1959 and that the 1,035 refers to the 21-pound satellite.

So the present JUNO II is approximately in the middle of the VANGUARD's range.

SENTRY-THOR is the best of all for this orbit; but, being a two-stage vehicle, it has no capabilities in the high-speed fields or high-orbital altitudes either.

The modified SENTRY-ATLAS is again better. The growth factor is down to 100. In other words, with 100-pound take-off weight, you orbit 1 pound. Other factors are earth-escapability of 450 and 24-hour

# GROWTH FACTORS OF SOME U.S. SPACE VEHICLES FOR TYPICAL MISSIONS

22

$M = \frac{\text{GROSS WEIGHT}}{\text{NET PAYLOAD}}$	96' ORBIT (306.6 N.M.)	EARTH ESCAPE	24 HR. ORBIT LUNAR SAT. INTERPL. PROBE	LUNAR SOFT LANDING
JUNO I	2,520			
VANGUARD	500-1035			
JUNO II	950			
SENTRY / THOR	240			
MOD. SENTRY / ATLAS	100	450	600	5,400
SUPER-ATLAS	36	145	208	1,940
JUNO V (STANDARD)	35	143	200	1,250
JUNO V (HEP)	25	118	143	830
JUNO V (NUCL)	≈ 8	≈ 20	≈ 30	≈ 67
6000 K BOO & NUCL	≈ 7	≈ 13	≈ 28	≈ 54

[REDACTED]

orbit of 600. The growth factor for the lunar soft landing is still very high at 5400 pounds per pound of payload.

Looking down Chart 10, you see that the figures get smaller and smaller. With the SUPER-ATLAS, it is down to 36; with the (standard) JUNO V, 35; and with the JUNO V with high energy propellant, down to 25. When you put a nuclear top stage on the JUNO V, you have a two-stage vehicle with a growth factor of about 8, which is 8 pounds of take-off weight for each pound in orbit.

And finally, with the 6,000K booster, (6 million-pound-thrust) and the nuclear carrier, this could possibly go down to 7. Correspondingly, the figures for earth escape, 24-hour orbit, and lunar soft landing also go down. But, even with all these tricks, the factor is still 67 to 54 for lunar soft landing, and this is a one-way mission - there is no provision for a return flight yet.

This is my last chart (Chart 11). It shows an over-all breakdown as to where we stand with all these payload capabilities. We have plotted here payload, again with a logarithmical scale, over orbital altitude in kilometers.

The first arrow indicates a 96-minute orbit. The 96-minute orbit corresponds to 306 nautical miles altitude. The second arrow indicates the escape equivalent. In other words, a circular orbit in this altitude requires a velocity equivalent to escape speed.

The third arrow indicates the 24-hour orbit which is essentially higher.

Beginning from the bottom of the chart, we have the JUNO I, VANGUARD, JUNO II, SCOUT, and so forth. You see, they have no capabilities in the higher orbits at all.

The same goes for the JUPITER/THOR-ABLE, the THOR-ABLE, and so forth, and with the NOMAD. Even the ATLAS-SENTRY in its present configuration cuts off; it has only about 100 pounds payload capability left at an orbital altitude of approximately 6,000 kilometers, and drops virtually to zero. In order to get into the 24-hour orbit, you have to have real power.





[REDACTED]

Payload-at-altitude calculations are very sensitive to the assumptions made. Just to show you how sensitive these values are, we have taken two figures here on the SUPER-ATLAS, which has the hydrogen-top stage fired from the ATLAS first stage. The set of figures which uses hydrogen/lox for the kick maneuver also, leads to the curve which, in the 24-hour orbit, would give you 1500-pound payload capability.

But, if we base these calculations on the same assumptions for cut-off accuracy, and so forth, that we have used in our own JUNO V using more conservative storable propellants for the kick, then these ATLAS figures would come down, according to this curve, and would give you in the 24-hour orbit a payload capability of practically zero.

So in this area things are extremely sensitive to the assumptions you make, and this should be very carefully analyzed before definite payload and schedule commitments are made.

Of course, when you go to the bigger units, you have ample room to spare and the argument then is whether you will have a 5,000 or 8,000 pound payload, but you are not contending with the zero.

So, if we want to get heavy payloads out to the 24-hour orbit or escape velocities, we need larger boosters. With that thought I will conclude the first part of the presentation.

DR. SILVERSTEIN: Thanks, Wernher.

During these presentations, to try to keep it informal, if there are any questions, let's have them. I am sure any of the speakers will be willing to have you break in and ask a few questions.

Are there any questions now about the various presentations before we go ahead?

GENERAL BOUSHEY: I have one very quick one.

The JUNO V showed a better M ratio than the ATLAS, I believe. Is that because of the shorter burning time and the greater acceleration?

I assume JUNO V is the clustered booster.

DR. VON BRAUN: Yes. Now, this "M" simply refers to the ratio of take-off weight to payload.

GENERAL BOUSHEY: I realize that.

DR. VON BRAUN: Of course, it is desirable to get that down.

In this area, a lot of things help -- good staging, high specific impulse, and size as such.

If you enlarge a rocket, just by enlarging it, the ratio between thrust and aerodynamic drag becomes greater and greater. A large increase in thrust results normally in a smaller velocity loss due to air drag. So sheer increase in size is also a gain.

All these things combined lead to these figures that we show here.

GENERAL BOUSHEY: Yes. That is, with the clustered, the same booster, is why I asked the question. The same basic rocket engine in one case is clustered and in one case is not.

No?

DR. VON BRAUN: Are you referring to this? (Chart 10 - items 6 and 7, Column 2).

GENERAL BOUSHEY: Yes, the 36 with the SUPER-ATLAS and the 35 with the JUNO V.

My understanding was it used the same basic rocket engine, in one case a cluster.

DR. VON BRAUN: No, I think the essential thing here is the following: the ATLAS, with the hydrogen-oxygen top stage, provides a higher specific impulse in the top stage than this one. On the other hand, it is a smaller vehicle. And the fact that these two figures are almost alike simply proves that by sheer increase in size, you pick up what costs you for the use of hydrogen-oxygen in the case of the smaller ATLAS; whereas, if you go to hydrogen-oxygen with the JUNO V also, then you come substantially down to 25. This is essential.

GENERAL BOUSHEY: Oh, there is no second stage on the JUNO V?

DR. VON BRAUN: Yes, yes. Shall we say the HEP JUNO V configuration corresponds to the SUPER-ATLAS. Both use hydrogen-oxygen in the top stages, but the HEP JUNO V is a larger vehicle and, therefore, has a smaller growth factor.

[REDACTED]

GENERAL BOUSHEY: I get it.

COLONEL HEATON: Also are there more stages in the JUNO V standard than in the SUPER-ATLAS?

DR. VON BRAUN: This depends on the application.

COLONEL HEATON: When you made up your supposition.

MR. KOELLE: The JUNO V is a three-stage and the SUPER-ATLAS a two and one-half-stage vehicle.

DR. VON BRAUN: Staging depends very much on the mission. For example, for a lunar mission or escape, there is no question that you will always need more stages no matter what you do. Whereas, for low orbits, you can do what the Russians did with the Sputnik III, and do it with the two-stager.

COLONEL HEATON: Thank you.

VEHICLE-MISSION COMPATIBILITY AND SYSTEM INTEGRATION

By

H. H. Koelle

[REDACTED]

## VEHICLE-MISSION COMPATIBILITY AND SYSTEM INTEGRATION

MR. KOELLE: My task is to illustrate what is required to arrive at a balanced program which would give us the desired results with available but limited resources.

This portion of the presentation could be entitled: Vehicle Mission Compatibility and System Integration.

To focus your attention on the over-all national picture again, let's show you again the national military and civilian space flight requirements (Chart 1).

What we actually are after is how many vehicles do we need essentially in these two fields of activity and how we can fit them into the over-all national space flight activities.

To give you a rough idea about the military side, we have listed here a few military missions (Chart 12) which require large rocket vehicles. We have to consider all these in the over-all picture. We have IRBM missions; ICBM missions; long-range rocket transportation possibly; ZEUS target drones; reconnaissance and weather satellites; global surveillance systems; communication and navigation satellites for military application; DYNA-SOAR; space defense system - that means more or less anti-satellite warfare and things of that nature; and finally, military space stations and orbital transportation, whenever they come into the picture. If you add these missile requirements up and compare them with the civilian requirements, then you obtain a plot like Chart 13.

This gives you for the next few years a fairly realistic picture on the over-all national (expected) vehicle requirements. Beyond 1965, it becomes hazy and can hardly be predicted at this time. The vehicle distribution depends upon what NASA's vehicle requirements finally will be. But nevertheless, there are military and civilian efforts (Chart 13) which we should always consider if we look at this program from the national point of view. However, we will concentrate on civilian requirements during the following discussion.

# TYPICAL MILITARY REQUIREMENTS

## ————— LARGE ROCKET VEHICLES —————

32

- ① IRBM (THOR & JUPITER)
- ② ICBM (ATLAS & TITAN)
- ③ LONG RANGE ROCKET TRANSPORTATION  
(REDSTONE, JUPITER, TITAN, JUNO V)
- ④ ZEUS TARGET DRONES (JUPITER, JUNO II)
- ⑤ RECONNAISSANCE & WEATHER SATELLITES (ATLAS - II7 L)
- ⑥ GLOBAL SURVEILLANCE SYSTEM (SUPER-ATLAS)
- ⑦ COMMUNICATION & NAVIGATION SATELLITES (SUPER-ATLAS, JUNO V)
- ⑧ DYNA-SOAR (SUPER-TITAN, JUNO V)
- ⑨ SPACE DEFENSE SYSTEM CARRIER VEHICLES (SUPER-ATLAS, SUPER-TITAN, JUNO V)
- ⑩ MILITARY SPACE STATIONS & ORBITAL TRANSPORTATION (JUNO V)

# TYPICAL U.S. LARGE ROCKET VEHICLE FIRING RATE

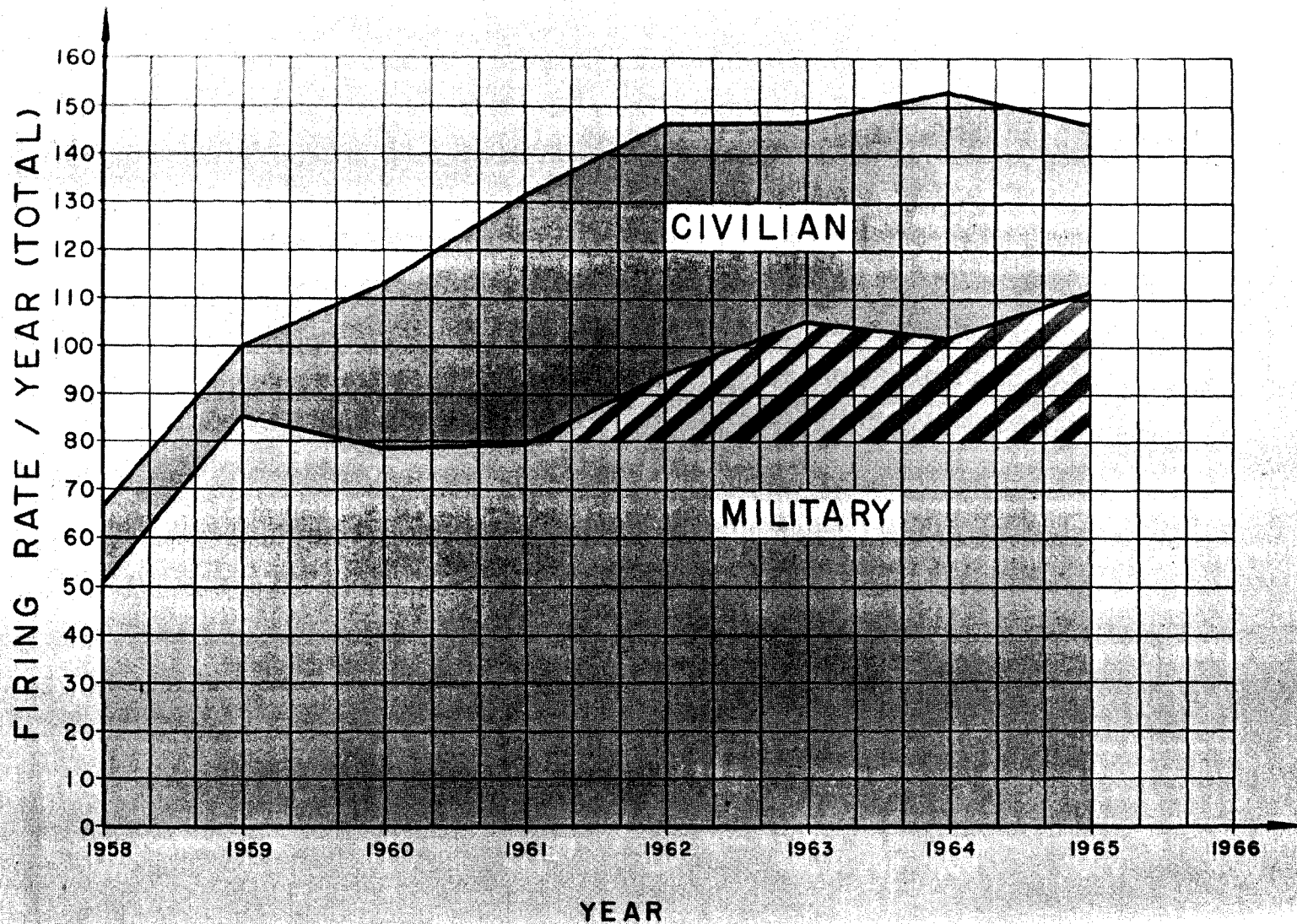

[REDACTED]

So what I want to go into in some detail now is the field of space research activities (Chart 2) which is of major interest to NASA. I will shortly illustrate requirements for orbital research, man-in-space, lunar research, planetary and interplanetary research, and solar research.

Before we go into the assumptions for these five subjects, I would like to define what one would call the "Golden Rule of A Feasible and Successful National Space Flight Program."

I believe it is not sufficient to balance only three parameters as is normally done - that is, mission, funds, and payloads. I think a total of eight parameters should be balanced. These eight are: mission requirements, vehicle capability, vehicle availability, vehicle reliability, schedule, funds, facilities, and teams.

All of these have to be balanced.

Now, we can simplify our statement by simply saying that what we need is an "integrated national vehicle program" to ensure maximum returns for our dollar.

Now, we should realize at the same time that space flight during the next ten years will be basically a problem of transportation. When we have solved the problem of rocket transportation, we can concentrate more on research and full exploration of space.

Now, the large number of military and civilian space-flight missions is going to require multi-purpose vehicles, instead of single-purpose vehicles. We just cannot afford to develop fifty vehicles for fifty missions. We have to try to live with a few vehicles in order to get reliability and economy - and I really mean just a few vehicles, preferably one in each class.

Now, the requirement for accomplishment of a large number of missions with the smallest possible number of vehicles shows clearly that the design of space vehicles can be accomplished successfully only by considering missions and other influencing parameters at the same time. Therefore, we had to develop a typical integrated national program as a model -- and I repeat, a model -- for studying various vehicle parameters.



[REDACTED]

Just to mention one, we cannot study booster recovery before we first have a feeling of what the firing rates are going to be because that has a very strong influence on which type of booster recovery system you would like to choose. So please don't misunderstand if we use the work "program"; it is a model program and it has nothing to do with what you should do, though this might indicate what could be done.

This milestone chart (Chart 14) is a good summary of what I want to go into in some detail during the next 15 minutes.

If we sum up all the expected space activities you will see in the next few charts, you will get an idea of the milestone program for the next ten years. I just want to mention a few.

We started our space flight activities in this country in January 1958 with the successful firing of our first earth satellite, which had a 20-pound payload.

The next highlight might come in June 1959, with the first 2,000 pound satellite capability.

In 1960, we might have, hopefully, the first manned orbital flight with an ATLAS one-man cabin, developed by NASA.

Further, we might have in June 1962 the first 20,000 to 30,000 pound orbital capability. Of course, we will have some other things in between; I am mentioning only the most significant milestones. We might have in August 1963, or thereabouts, the first 5,000 to 10,000-pound lunar soft landing capability.

In about November, the fall of 1964, we might be able to establish the first permanent equatorial space station.

And last, but not least -- this we consider a very important point -- maybe, in the spring of 1967, we will have developed a capability of putting the first man on the moon. And we still hope not to have Russian Customs there.

Therefore - and keep this in mind - we want to have these capabilities so that in case it is desirable to use them we will be ready.

# ANTICIPATED MILESTONES OF A TYPICAL U. S. SPACE FLIGHT EFFORT

- |             |   |             |  |
|-------------|---|-------------|--|
| 31 JAN 1958 | FIRST 20 LB. SATELLITE (JUNO I)                           | MAR 1963    | ESTABLISHMENT OF 4 MAN EXPERIMENTAL SPACE STATION          |
| 11 OCT 1958 | FIRST 35 LB. Cislunar PROBE (THOR-ABLE)                   | APR 1963    | FIRST UNMANNED LUNAR CIRCUMNAVIGATION                      |
| DEC 1958    | FIRST 300 LB. SATELLITE (SENTRY/THOR)                     | JUN 1963    | FIRST OPERATIONAL 24 HR. COMMUNICATION SATELLITE           |
| FEB 1959    | FIRST 15 LB. LUNAR PROBE                                  | AUG 1963    | FIRST 5,000 TO 10,000 LB. LUNAR SOFT LANDING               |
| JUN 1959    | FIRST 2,000 LB. SATELLITE (SENTRY/ATLAS)                  | NOV 1963    | FIRST SOLAR PROBE  |
| SEP 1959    | FIRST MACH 7 FLIGHT OF X-15                               | JUL 1964    | FIRST 16 MAN ORBITAL RETURN FLIGHT                         |
| DEC 1959    | FIRST MANNED ROCKET FLIGHT (REDSTONE)                     | NOV 1964    | FIRST MARTIAN SATELLITE ATTEMPT                            |
| OCT 1960    | FIRST FLIGHT TEST OF 1,500 K BOOSTER (JUNO V)             | NOV 1964    | ESTABLISHMENT OF 20 MAN PERMANENT EQUATORIAL SPACE STATION |
| NOV 1960    | FIRST 10,000 LB. ORBITAL CAPABILITY                       | SEP 1965    | FIRST MANNED LUNAR CIRCUMNAVIGATION                        |
| DEC 1960    | FIRST 2,000 LB. INTERPLANETARY PROBE (SUPER-ATLAS)        | OCT 1965    | FIRST ATTEMPT OF VENUSIAN INSTRUMENTED SOFT LANDING        |
| DEC 1960    | FIRST MANNED ORBITAL FLIGHT (ATLAS)                       | SUMMER 1966 | FIRST 50,000 LB. ORBITAL CAPABILITY                        |
| JAN 1961    | FIRST VENUSIAN PROBE (SUPER-ATLAS)                        | DEC 1966    | FIRST ATTEMPT OF MARTIAN INSTRUMENTED SOFT LANDING         |
| JUN 1961    | FIRST 24 HR. /1,000 LB. COMMUNICATION SATELLITE PROTOTYPE | SPRING 1967 | FIRST MANNED LUNAR LANDING AND RETURN                      |
| AUG 1961    | FIRST LUNAR MAPPING SATELLITE (SUPER-ATLAS)               | FALL 1967   | ESTABLISHMENT OF 50 MAN PERMANENT SPACE STATION            |
| JUN 1962    | FIRST 20,000 TO 30,000 LB. ORBITAL CAPABILITY             |             |  |
| JUN 1962    | FIRST 5,000 TO 7,000 LB. INTERPLANETARY PROBE             |             |  |
| AUG 1962    | FIRST VENUSIAN SATELLITE ATTEMPT                          |             |  |
| OCT 1962    | FIRST 5,000 LB. MARTIAN PROBE                             |             |  |
| NOV 1962    | FIRST 2 MAN CONTROLLED ORBITAL RETURN FLIGHT              |             |  |

[REDACTED]

Along this line, I now want to go into certain sub-programs: the orbital research type of missions; the man-in-space; lunar and cislunar activities; and the planetary activities. And, afterwards, I want to illustrate how these things really have to tie together.

Now, the next five charts give you a relationship between the mission indicated and the vehicles required, and again this is just typical. Don't pay too much attention to the figures given on the charts.

Let's take a look at a typical orbital research program (Chart 15). We start with small payloads, go to medium payloads, to larger payload requirements for meteorological and communication - as well as for high altitude research satellites, and finally to orbital cargo transportation for space stations.

The black symbol shows good results and the white shows failures assuming the vehicles are available time wise. This should indicate to you that if you have requirements for ten successful vehicles, it is not sufficient to order ten, rather ten divided by the average reliability expected.

In the second and third lines, I just wanted to indicate that the VANGUARD precedes the SCOUT; that the JUNO II fills the gap until the SCOUT becomes available; and that the SCOUT then takes over until approximately mid-1965. Then we might find that whenever we establish a permanent satellite sometime in 1965-70 time period, it might be more convenient and economical to launch small probes from the satellite because there you have certain advantages. First, you would have greater flexibility; and, second, you would have the great advantage of the small growth factor of the large carrier vehicles, which would make it more advantageous to carry the small probe payloads into orbit with a large vehicle and launch them from this orbital platform.

These two SUPER-ATLAS vehicles at the end of 1963 tie in with Mr. Ehrlicke's proposal for a four-man experimental space station with which you might be familiar. SUPER-ATLAS is the transportation

# TYPICAL ORBITAL RESEARCH PROGRAM

38

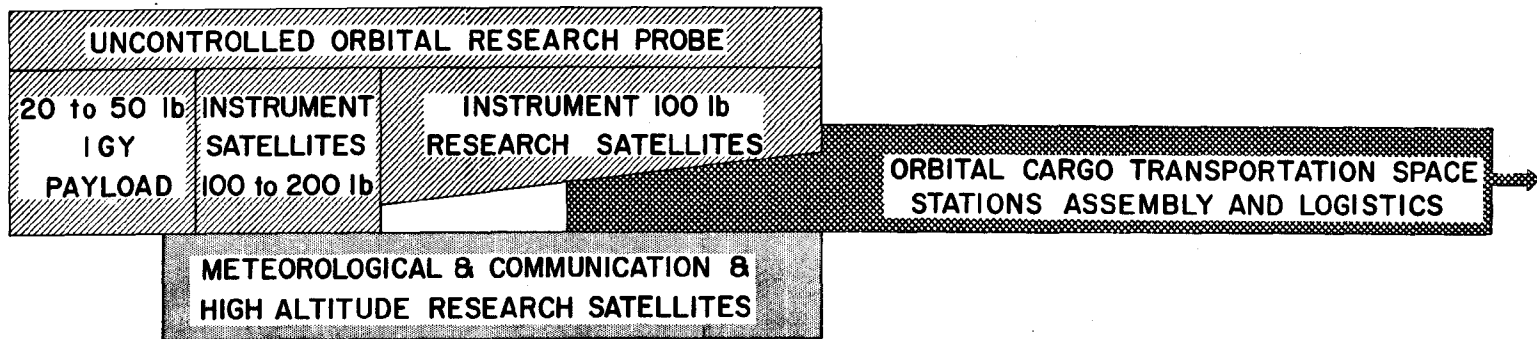
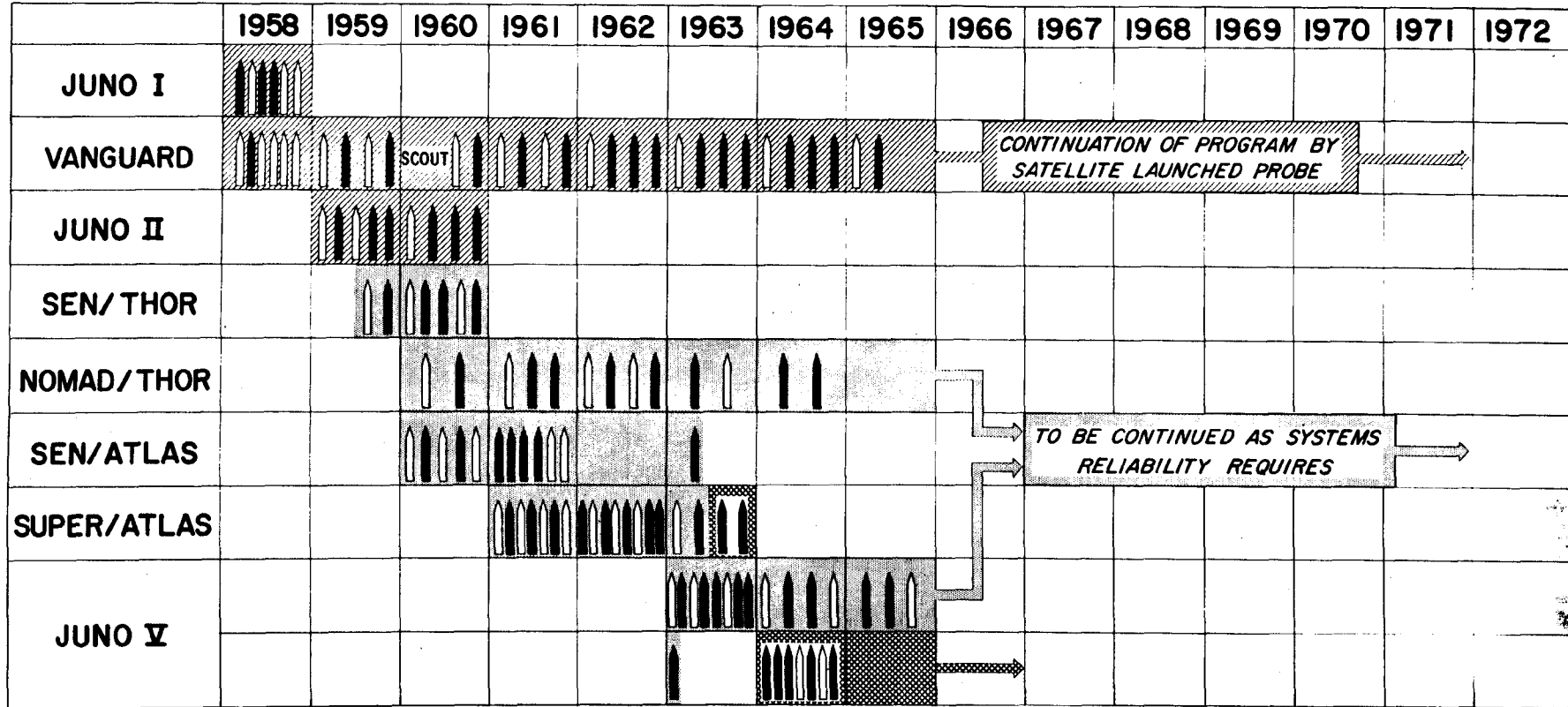

he needs. Whenever we go to a larger manned operation shown in 1964 JUNO V will provide the required transportation.

Now, the next typical sub-program in which you are very much interested is the man in space (Chart 16).

We are starting out with a few REDSTONES which have been ordered just recently for testing the cabin. Then, we anticipate a program for training the crews to go into orbital carrier vehicles in 1961 through 1963. Then, we have one-man orbital carrier capability in 1960/62, first possibly using the ATLAS as it is, and then going to the SENTRY-ATLAS for more capability; by 1963 the SUPER-ATLAS takes over with a capability for orbiting a four-man crew. And 1964/65 we go to the JUNO V which would have the capability for orbiting something like a 16-man capsule. Such a return vehicle could be enlarged as the capability for transportation is increased.

Finally, we get into the activities of space stations and lunar flights. These also involve man in space, of course. The program we are looking at first under Space Stations (Chart 16) might be Mr. Ehricke's four-man experimental station; then you might think of a 20-man permanent satellite. After a few months' experience you might build this permanent station into a real research center.

Under lunar flights (Chart 16), we might start out with lunar circumnavigation with manned vehicles. If the Russians are serious about celebrating their fiftieth anniversary in the fall of 1967 on the moon, then, we should think of something like a two-man lunar landing in early 1967.

A few years later, around 1970, we might go into sending 30 men on a scientific lunar expedition. This whole area beginning 1970 becomes questionable.

Now, the next sub-program we are interested in is a typical cislunar research program (Chart 17). We have here a THOR-ABLE which was one-half a mission success; and a JUNO II which was also not completely successful.

# TYPICAL MAN-IN-SPACE PROGRAM

40

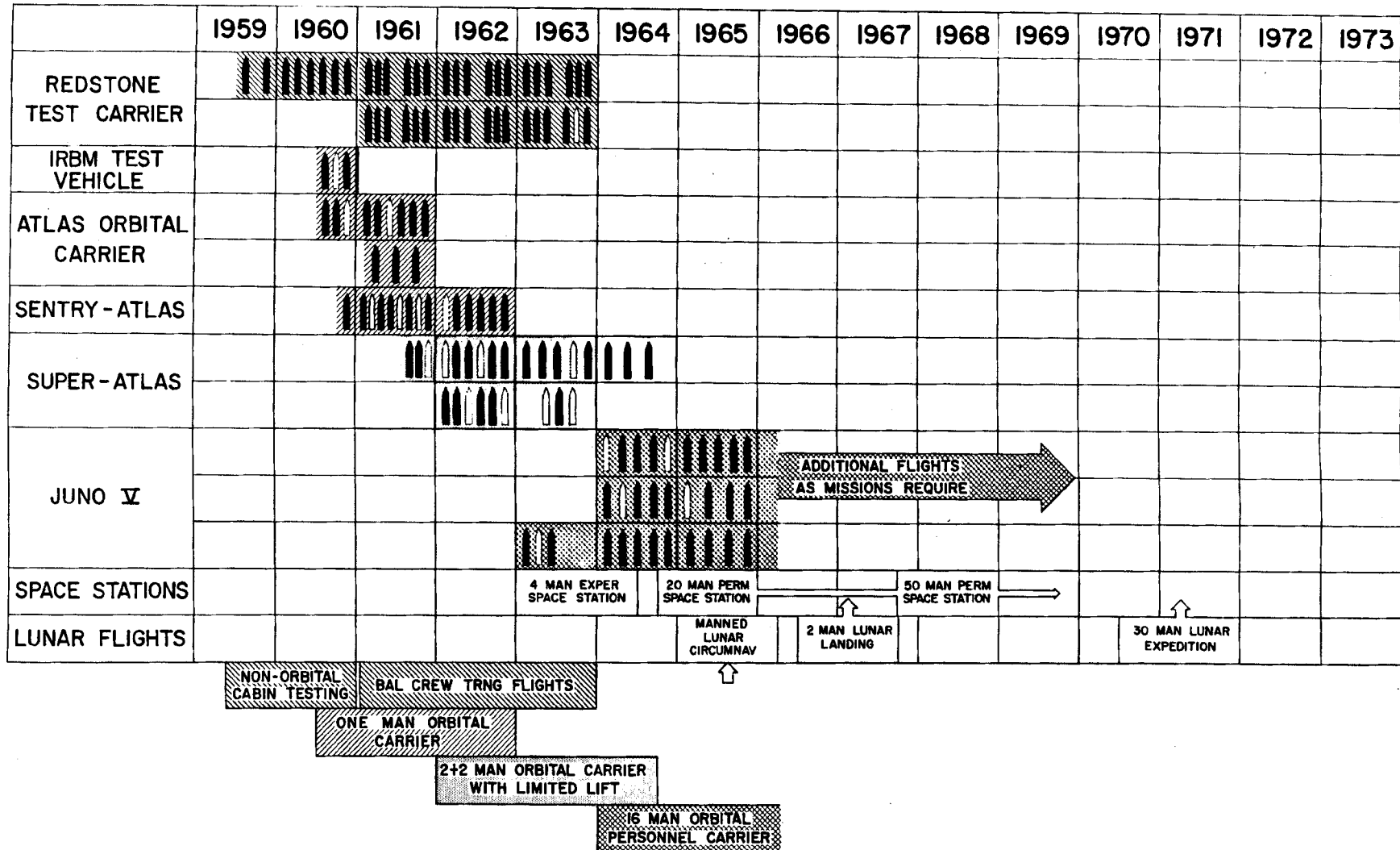

# TYPICAL CISLUNAR AND LUNAR RESEARCH PROGRAM

	1958	1959	1960	1961	1962	1963	1964	1965	1966	1967	1968	1969	1970	1971	1972
THOR ABLE	🚀🚀🚀🚀														
JUNO II	🚀🚀	🚀🚀													
SUPER-ATLAS				🚀🚀	🚀🚀🚀										
JUNO V						🚀🚀🚀🚀	🚀🚀🚀🚀	🚀🚀🚀🚀							
							🚀🚀🚀	🚀	CONTINUED AS MISSIONS REQUIRE →						

15-50 LB.  
LUNAR  
PROBES

50 LB.  
VERY HIGH  
ALTITUDE

500 LB.  
LUNAR SAT.  
(MAPPING)

INSTR. LUNAR  
CIRCUM-  
NAVIGATION

2000 lb  
LUNAR  
SAT.

2 MAN  
LUNAR  
CIRCUM

1000 LB.  
LUNAR  
SOFT LANDING

2 MAN  
LUNAR  
LANDING

30 MAN  
LUNAR  
EXPEDITION

[REDACTED]

The capabilities of JUNO II and THOR-ABLE are limited; they are guidance-wise on the marginal side. We would like to suggest for this mission to concentrate on the SUPER-ATLAS and JUNO V because they have the most promising capabilities. We like to call the SUPER-ATLAS a "work pony", and the JUNO V the "work horse" in space work.

Even the work horse has a few flops or random failures, as you see (Chart 17), because of the large number of components involved in the three-stage configuration.

This lunar research program is a program which is, again, just typical; it starts out with small probes in the 50-pound class at high altitudes just to get going. There are two extra JUNO II's as vertical probes.

We get, with SUPER-ATLAS or our "work pony", our first really reasonable and non-marginal capability for a lunar-mapping satellite and, hopefully, for a 500-pound or so soft-lunar-landing capability.

When we get to the lunar-landing area, we have to cut off our guess work in the area of vehicle requirements because the mission picture is rather hazy and would depend very much on your plans as to what you are planning to do.

DR. GLENNAN: Does that chart indicate you would expect the first firing of the SUPER-ATLAS to be substantially before 1961 or partially successful for the first one fired?

MR. KOELLE: Yes, the first one fired on this mission.

See, there are the other missions superimposed.

DR. VON BRAUN: This is only the cislunar research program. The previous chart showed the orbital requirements. You have to take the two together.

MR. KOELLE: So, from here on, we conclude our considerations because they depend too much on the development of the state of the art and on your plans.



[REDACTED]

Now, the last program of interest is the typical interplanetary, planetary, and solar research program (Chart 18). This is, compared to the others, relatively minor. It is only a beginning because we just do not have the required capabilities in the next few years.

In our first category (Chart 18), we are talking about purely interplanetary probes where it is not imperative that we come within a certain distance of a planet. These are similar to our present lunar shots, Venus shots, and other activities. We have to watch the planet schedules because only at certain times can we go to certain planets.

Our guess is that you would start to build up in sophistication, starting first to pass by the planet and take a picture; then possibly you would like to have a satellite available for mapping, which could be scheduled for Venus in early 1964. Then the next scheduled time period that you are able to go out after Venus, you might go for a soft landing. And then you might select various missions for the next possible departure dates.

The Mars exploration is similar. It is interesting to note that we might go to Venus first, because, although Mars will be available in 1962 for a rendezvous, we won't have the SUPER-ATLAS available at that time, at the best a rather limited capability of a few hundred pounds which must be considered marginal.

The first solar probes will of course, just go into the neighborhood of the sun; then maybe you will want to put a satellite in orbit around the sun; and finally, you might even try to hit the sun and go into it with a direct probe.

These are the detailed sub-programs. Now, if you add these things up -- orbital research, man in space, cislunar and lunar research, interplanetary and planetary research, solar research -- watching carefully time schedule and carrier vehicle availability, we get what we like to call "mission-vehicle capabilities" (Chart 19).

First, there is orbital research. Here we start out with large probes in the 100-pound class. This effort will decrease and will be cut off a few years from now. Also under orbital research (Chart 19)

# TYPICAL INTERPLANETARY, PLANETARY AND SOLAR RESEARCH PROGRAM

44

	1960	1961	1962	1963	1964	1965	1966	1967	1968	1969	1970	1971	1972	1973	1974
SUPER-ATLAS		↑													
		↑↑	↑↑												
JUNO V			↑	↑↑	↑	↑↑↑									
			↑↑		↑↑	↑↑	↑↑	VEHICLES AS REQUIRED BY CONTINUATION OF PROGRAM →							

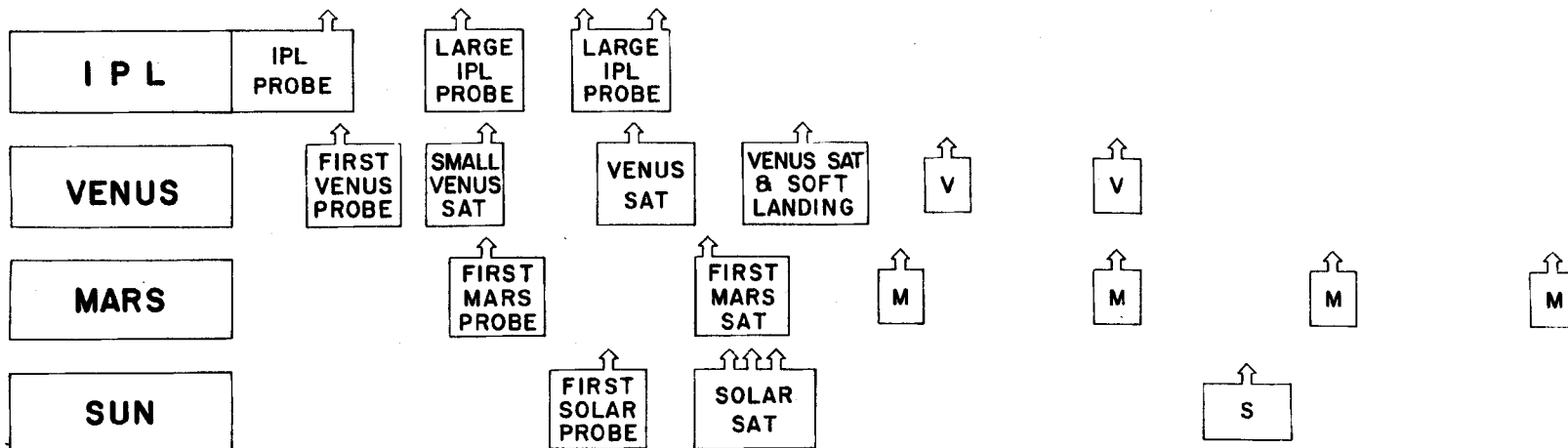

# U. S. SPACE RESEARCH

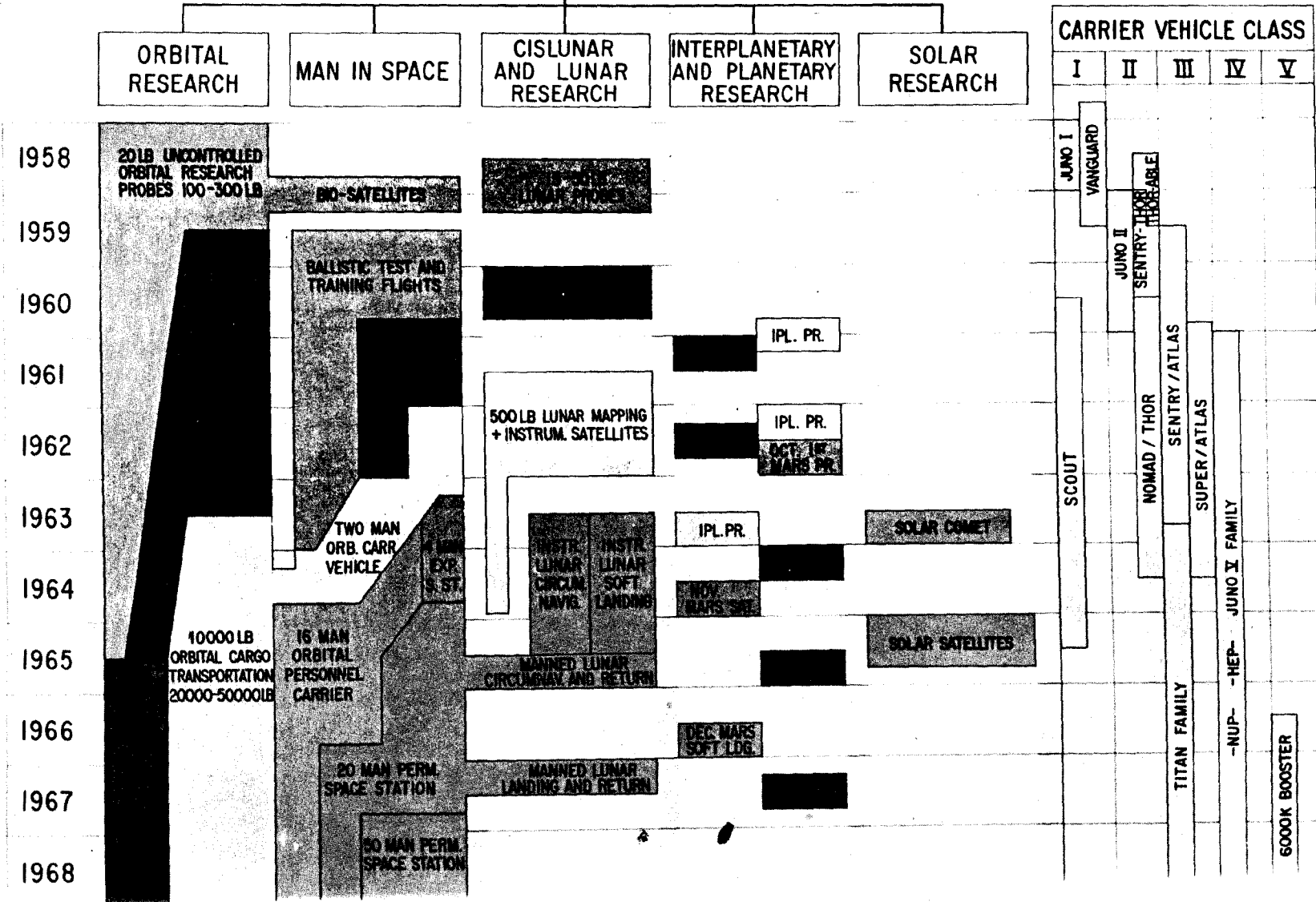

[REDACTED]

you see that we expect certain activities with medium satellites, which will be continued for quite some time. As you can see from this chart, there is a definite relationship between orbital research and man in space. You are helping the man-in-space program with bio-satellites first; then later you demonstrate the capability to put into orbit a payload of the size required to establish manned space stations.

A four-man space station is indicated in 1963-64, and you will note the SUPER-ATLAS is available during this time period.

Then you might go to a 16-man orbital personnel carrier. We feel very strongly about the necessity for this because, from here on, you simply cannot do much in space if you talk about orbital activities and orbital refueling without having a carrier available which brings say, 10 to 20 people into orbit and back, more or less rotating the personnel.

The man-in-space effort dovetails with the lunar and cislunar activities because you simply can't land a man on the moon before you have established a man-in-space capability; that is quite clear. So Chart 18 demonstrates, more or less, a typical program where missions, vehicle capabilities, and schedules are to be integrated into an over-all space program. It is further necessary to integrate this with the military program, just to give you an idea of the job ahead.

Now, the next charts are merely arithmetic, and they give a total of the vehicles I showed you in the other charts just to give you a feel of how such a typical program adds up. The figures should not be taken as exact, but it should give us just an idea of the number of vehicles required in our typical program. So I would suggest that the figures given be disregarded to a certain extent because they will change in reality anyway.

We would like to illustrate in these charts rather the approach taken (Chart 20). What we are doing in our arithmetical procedure is taking from all programs the vehicle requirements and finding out how many of the different type vehicles are needed. These are then plotted against time until 1965. We can only go so far; then requirements become hazy.

# TYPICAL NASA VEHICLE REQUIREMENTS AND FIRING PLAN

		1958	1959	1960	1961	1962	1963	1964	1965	
A	JUNO I	3 2 1								
B	VANGUARD	2 3 1	3 1							
C	SCOUT			1 1	1 1 1 1	1 1 1 1	1 1 1 1	1 1 1 1	1 1	
D	JUNO II		1 1 2 2 1	2 1 2 1						
E	THOR - ABLE	2 1	2							
F	SENTRY/THOR		1 1	2 3						
G	NOMAD/THOR			1 1	1 1	1 1 1 1	1 1	1 1		
H	SENTRY/ATLAS			2 4	5 3 3 3	3 3				
I	SUPER-ATLAS			1	3 3 3 6	6 5 7 7	3 3 3 3 3			
J	TITAN FAMILY									
K	JUNO V			1 1 1	2 1 2 3 2	3 4 5 6	6 9 13 14	10 8 8 8		
L	6,000 K THRUST VEH.									
m	REDSTONE			2 1 2 3	1 1 1 1	1 1 1 1	1 1 1 1			
n	THOR/JUPITER			1 2	(3)(3)(3)(3)	(3)(3)(3)(3)	(3)(3)(3)(3)			
o	ATLAS			3 3 3 3			1			

[REDACTED]

In the left hand column of Chart 20 are some symbols we are using on the next chart (Chart 21) where we have plotted the same vehicle requirements, not against vehicles but against missions this time, to see what our requirements are in each of the various mission areas.

After you have your vehicle requirements, the next thing you have to watch is that there is a certain lead time in ordering these vehicles; so we have to move requirements for vehicles not available from military stockpiles up about two years on the average (Chart 22). That gives you an idea about the typical schedule for ordering vehicles.

All you have to consider now is cost per firing.

This is a typical set of such cost assumptions. To give an example, the first SUPER-ATLAS might cost, \$6 million. This goes down as more are produced, and maybe it will come down to \$3.5 million per flight (Chart 23).

Now, this chart (Chart 24) includes a total expenditure per vehicle program. So if you go through this exercise and multiply the figures in Chart 23 by those in your purchasing chart (Chart 22), then you get a dollar figure, (in millions of dollars) per fiscal year, in this case - for each of the vehicle programs. And then we have plotted this figure against time to obtain this distribution of cost versus calendar year and fiscal year (Chart 25). The fiscal year is marked by the broken line. What we feel is rather encouraging is that the total vehicle cost of the sizeable space research program I have illustrated is still in the area of about \$250 million per year.

Now, normally, people are a little bit afraid of adding these things up because they don't want to scare themselves or others. As you see, we decided to try to add them up. Since it turned out to be a reasonable amount, we will show it to you. If it had been unreasonable, we wouldn't have shown it to you. So I feel this \$250 million is something in the right order of magnitude and something which we definitely can consider to be feasible.







# ASSUMPTIONS FOR VEHICLE COST PER FIRING

MILLION DOLLARS

		1958	1959	1960	1961	1962	1963	1964	1965	
A	JUNO I	2.0								
B	VANGUARD	8	8							
C	SCOUT	1.5	1.5	1.5	1.0	0.9	0.8	0.75	0.70	
D	JUNO II	4.0	3.0	2.0						
E	THOR-ABLE	3.0	3.0							
F	SENTRY / THOR	3.0	3.0	3.0	2.5	2.5				
G	NOMAD-THOR	5.0	4.0	3.0	2.0	2.0	2.0			
H	SENTRY / ATLAS		3.0	3.0	2.5	2.5				
I	SUPER-ATLAS	6	5	4.5	4.0	4.0	3.5	3.5		
J	TITAN FAMILY			3	2.5	2.5	2.4	2.3	2.2	
K	JUNO V	12	10	9	8.5	8	7.5	7.5	7.0	
L	6,000 K THRUST VEH.									⇒
m	REDSTONE	} MAN IN SPACE	2	2	2					
n	THOR / JUPITER		2	2	2					
o	ATLAS		3.0	2.5	2.0	1.9	1.80	1.70		

# EXPECTED EXPENDITURE FOR VEHICLES FOR TYPICAL INTEGRATED SPACE RESEARCH PROGRAM

( PHASE I )

MILLION DOLLARS

52

FISCAL YEAR		1958	1959	1960	1961	1962	1963	1964
A	JUNO I	12						
B	VANGUARD							
C	SCOUT		15					
D	JUNO II	20	24					
E	THOR-ABLE	9	6					
F	SENTRY / THOR	21						
G	NOMAD / THOR (JUP)		15	20	15			
H	SENTRY / ATLAS		18	42	15			
I	SUPER-ATLAS		80	99	36	36		
K	JUNO V		48	40	105	237	325	112
L	6,000 K THRUST VEH.							⇨
m	REDSTONE		16	8	8	8		
n	THOR / JUPITER		6					
o	ATLAS		27	12				
								○

# TOTAL EXPECTED VEHICLE EXPENDITURES

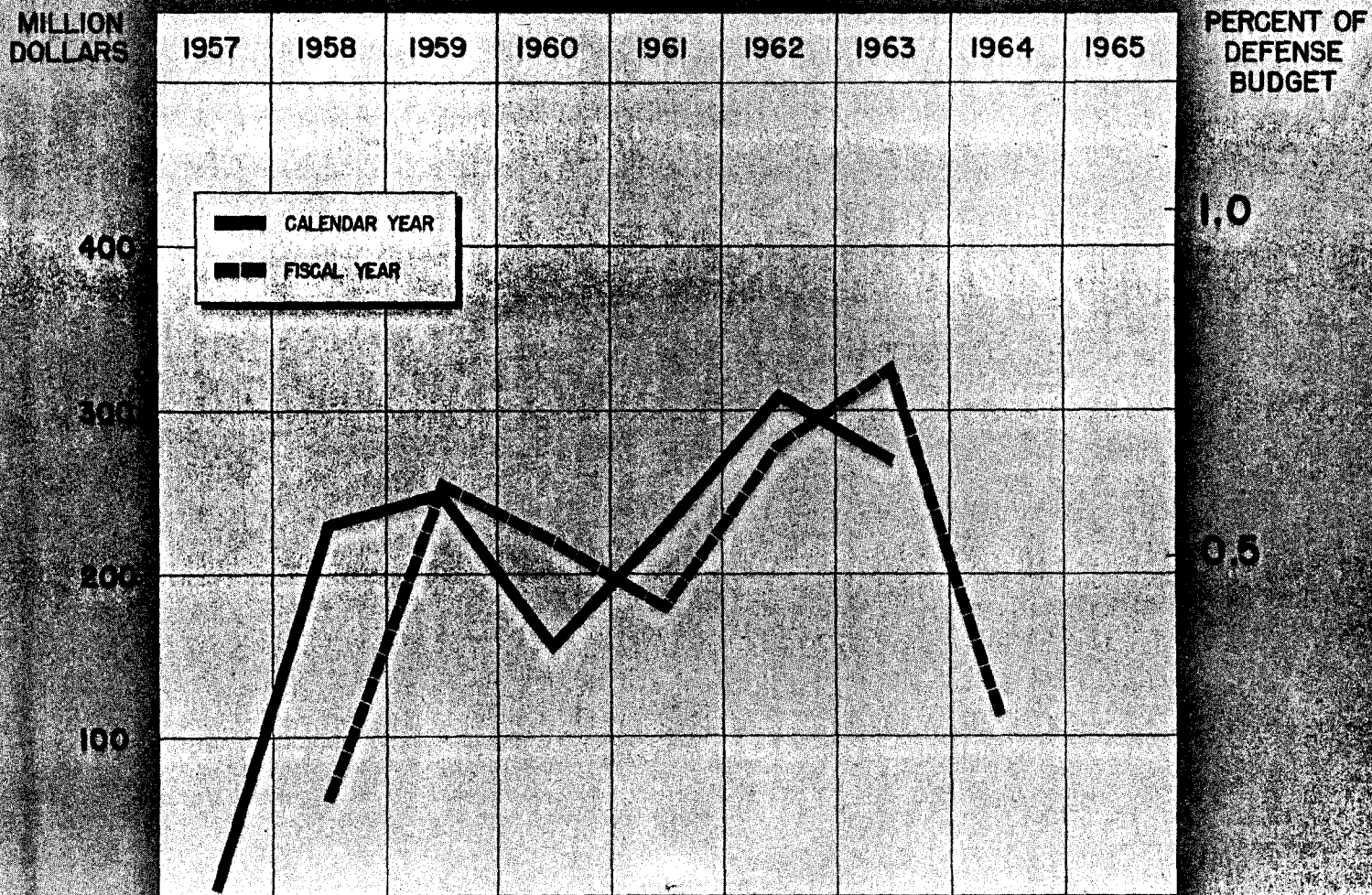

[REDACTED]

DR. VON BRAUN: Shouldn't you say at this point, Mr. Koelle, that this is based on the assumption that a vehicle program is planned by NASA somehow jointly with the Department of Defense, so that you can really go ahead and buy military vehicles, and don't have to develop special vehicles all the way through.

DR. GLENNAN: Right.

MR. KOELLE: That is the assumption of our cost chart.

DR. GLENNAN: That is the purpose of the meeting, talking about space, not missiles.

MR. KOELLE: Right.

DR. VON BRAUN: I think that is borne out on the previous chart. It is assumed you can buy an ATLAS for \$4 million.

DR. SILVERSTEIN: One question here, the development cost of your vehicles is not included in these costs?

MR. KOELLE: We have included the missile development cost but not normally the development cost of the engines. For example, we priced the first JUNO V to be delivered to ARPA at \$20 million and they cover most of the basic engineering and development cost.

DR. SILVERSTEIN: This is really the cost for hardware.

MR. KOELLE: This is correct.

The figures given in Charts 24 and 25 do not include component development cost. But, whatever addition development (i.e., product improvement) that goes into the program later is depicted in these charts.

DR. DRYDEN: This is the total program, military plus civilian?

MR. KOELLE: No, only civilian type space missions. Military programs are not shown at all in this set of charts.

DR. VON BRAUN: I think it would include adaptation of existing military carriers to special space missions in addition to the pure research, no more than that.

DR. SILVERSTEIN: For example, it doesn't include such things as the development of a million pound single-chambered rocket, nor does it include the true development cost of some of the upper stages that you show on your chart.

[REDACTED]

DR. VON BRAUN: No, but let me illustrate. Suppose you pick SUPER-ATLAS, and, say, I want to make a soft landing on the moon with that thing. Then you would pick the ATLAS for the hardware cost, you would pick the Pratt-Whitney engine -- that is being developed and is already funded...

DR. SILVERSTEIN: What I am saying is that for the first SUPER-ATLAS, you show \$6 million. It is going to be a \$40 million or \$50 million development program to bring it to the stage of the first SUPER-ATLAS.

DR. VON BRAUN: That's right.

MCKENNEY: You do not include the payload cost either, do you?

MR. KOELLE: We are discussing here the vehicular programs only, e.g. the trucks not the cargo. As shown in Chart 26, we have to have component development, advanced engines; guidance components; Starfinders; horizon seekers; facilities. For example, somebody has to pay for an equatorial launch site one of these days. Then there is supporting research; administration; flight range operation, whatever this costs; and payloads -- to answer the other question.

Now, we cannot determine very easily how much this will cost, but our feeling is that you have to add at least the same amount as for the vehicles for each program. So it is on the average of \$500 million per year. But, we feel that this model program with the estimated expenditure is the type of program that will probably fit the needs of the country; but that is something, of course, you will have to determine.

Now, what do we get for the money? That is always a very interesting question. Here we have plotted the tons of accumulated payload in orbit versus time (Chart 27).

You might remember very often people ask whether or not we clutter up space too much, or how many satellites do we have at what time and in which orbit. This is only a fair indication of what we get with respect to mass accumulated in various orbits.

We have adjusted all our payload capabilities to two typical missions

# ITEMS NOT COVERED IN COST ESTIMATES

- ① COMPONENT DEVELOPMENT
- ② FACILITIES
- ③ SUPPORTING RESEARCH
- ④ ADMINISTRATION
- ⑤ FLIGHT RANGE OPERATION
- ⑥ PAYLOADS

# ACCUMULATED PAYLOAD WEIGHTS

TONS OF  
PAYLOAD  
1000

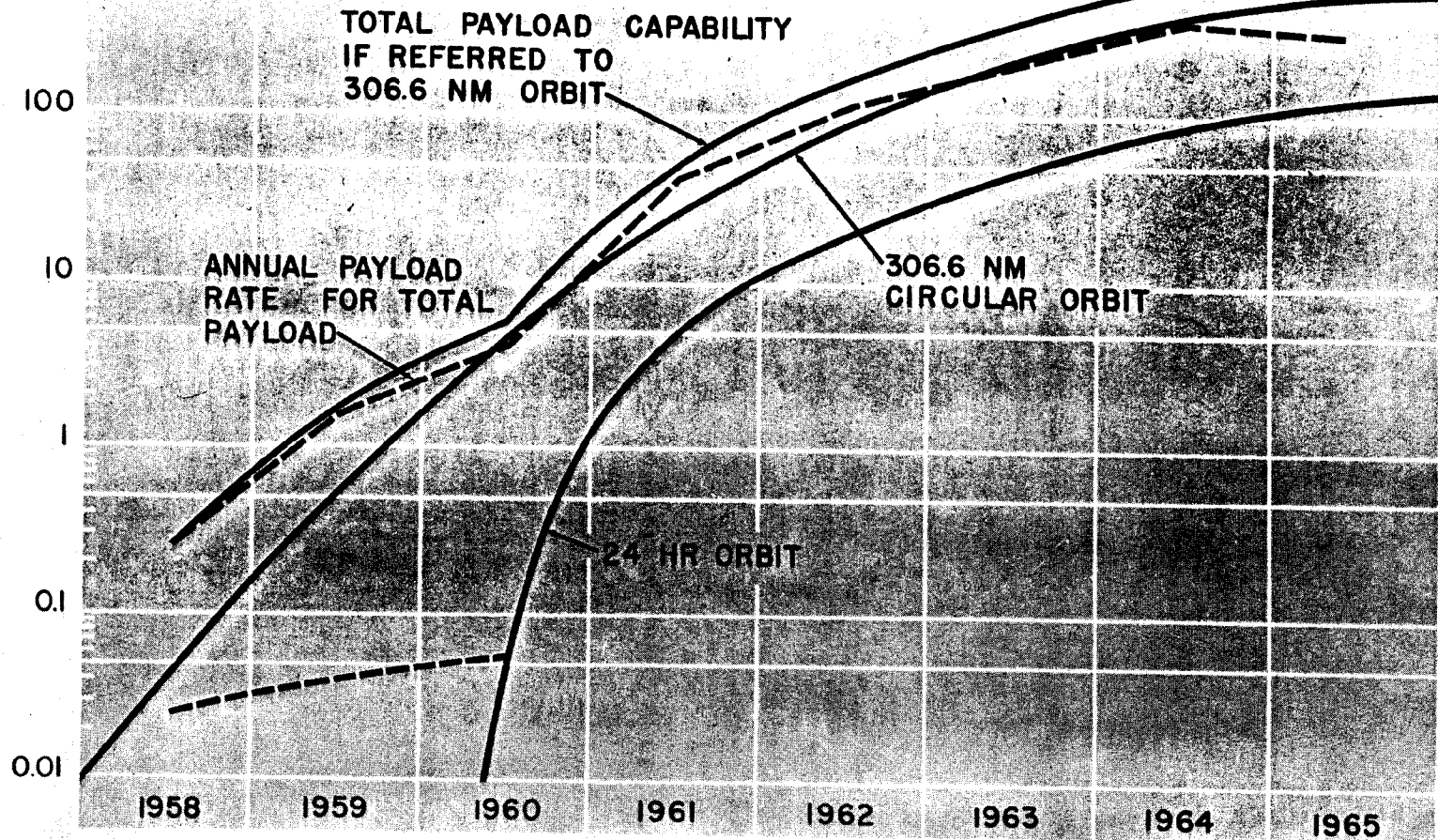

[REDACTED]

here -- one is the 306 nautical mile orbit. Furthermore, we have adjusted all space missions to the 24-hour orbit, because, as you might remember, the energy requirements are approximately the same.

So by adding these capabilities up, we get as totals, in the 24-hour orbit, about 100 tons at 1965; and in the 306 nautical mile orbit, something like 500 tons.

Now, if you adjust this 24-hour orbit capability to the capability at 306 nautical miles, then you get the upper curve shown in Chart 27, which is your total capability. And if you consider the reliability they are expected to have, all into the 306 nautical mile orbit, then you would end up with about 1,000 tons in this typical orbit in 1965.

Now I want to derive one very important figure - and I think if you want to recall this as the only one from this presentation, this will be worthwhile. If you take our total figure for transportation, and divide it by total payload in orbit, then you arrive at an average of \$750 per pound payload with the 306 nautical mile orbit as a reference. So this is a good average to be expected for the next five years.

There are always a few people, of course, who are interested in more than this one figure namely in future cost trends, and I don't want to conclude my briefing without showing to you that costs will come down. The next chart will prove to you that costs will come down.

This chart (Chart 28) shows cost-per-pound payload versus time for typical missions indicating the improvement of the state of the art as you can see. The cost-per-pound payload will come down within the next 15 years considerably.

I don't say the NASA budget will come down, but that the cost-per-pound-payload trend versus time for typical missions is downward. That is for the transportation vehicles only.

It may be surprising but if you add up the individual influences like the increasing vehicle capability, increasing size of the vehicle - which results in better efficiency - and more experience, you have then for various vehicles, a considerable reduction in cost-per-pound



# COST PER POUND PAYLOAD TREND VS TIME FOR TYPICAL MISSIONS

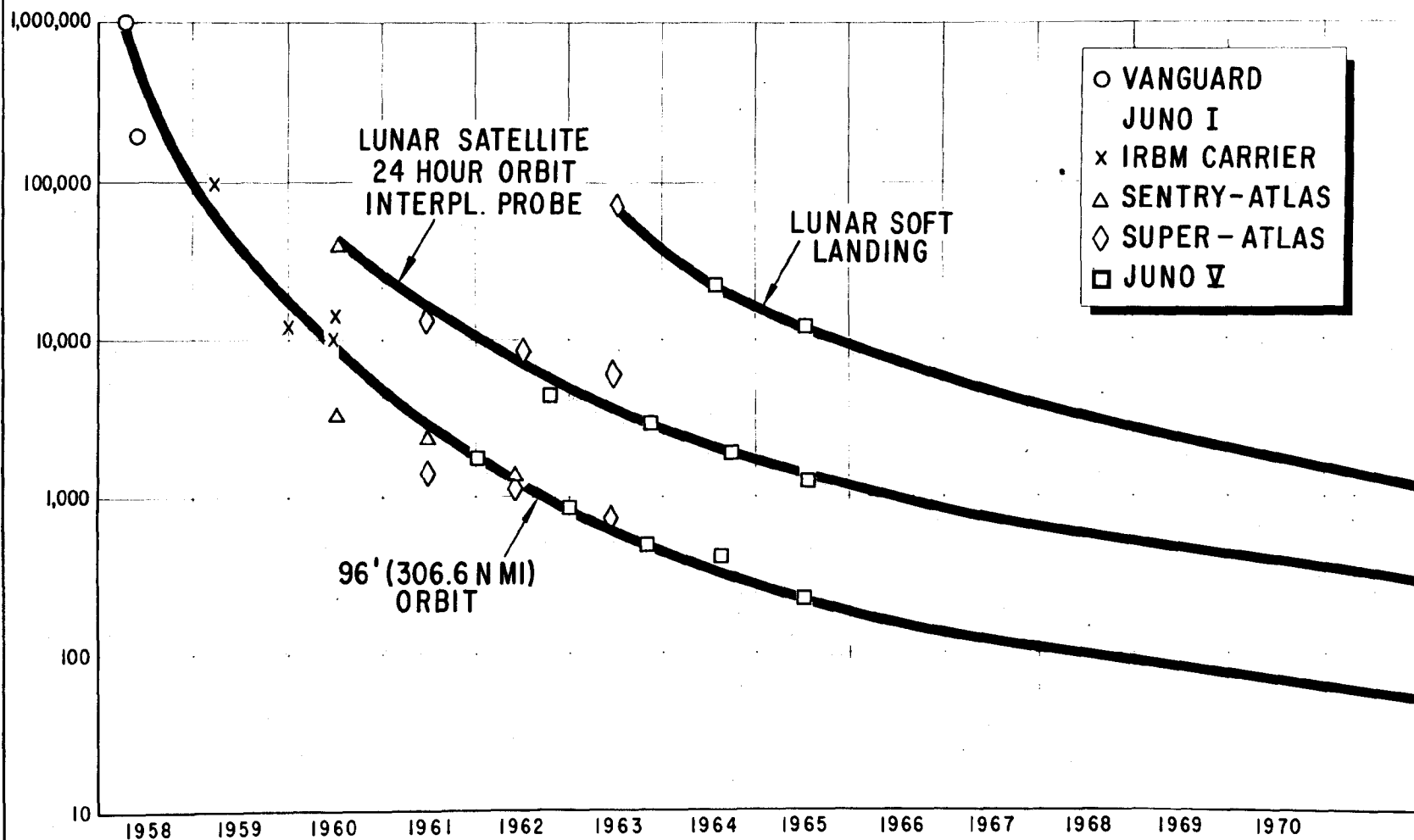

payload. And we really didn't cheat here too much, these figures come out that way.

So we have a hope, if our assumptions are correct, that about mid-1968 we will get a figure of \$100 per pound payload in orbit for the 306 nautical mile orbit.

If you go into the 24-hour orbit, we can expect a figure of say \$1,000 per pound by mid-1966. And lunar soft landing, again, is a little bit more uncertain, but this extrapolation, if correct, indicates that by about 1972 we might have a figure of \$1,000 per pound payload on the moon.

Now, what does this show? If we are talking about commercial space flight, we are saying if costs become reasonable, we might attract the private customer. For example, if a guy weighing 180 pounds has a home worth \$18,000, he can sell it at this time and get a ticket for a ride into this orbit.

Thus, we conclude and predict with certainty that costs will come down as we go along.

And this concludes my part of the presentation.

DR. SILVERSTEIN: Thank you.

Are there questions or discussion here?

I think you might give your name as you ask your questions so we may get a record of it on our stenotype operation here.

Well, that seemed to be very thorough because we don't have any questions.

I think that we could break here now. I think we are a few minutes early.

MR. KOELLE: We might need those 10 minutes I saved for the JUNO V portion of the presentation. We have quite a few charts.

DR. SILVERSTEIN: All right.

ABMA CONTRIBUTIONS  
IN THE AREA OF EARTH-LAUNCHED VEHICLES

By

Dr. Wernher von Braun

[REDACTED]

ABMA CONTRIBUTIONS  
IN THE AREA OF EARTH-LAUNCHED VEHICLES

DR. VON BRAUN: For the sake of completion, let me first say we are already working in several fields for NASA. We have an assignment to prepare eight JUNO II vehicles for NASA in 1959 and early 1960, of which six will probably be used for orbital flights and two for high altitudes or escape missions, particularly in connection with the radiation belt.

In addition to these eight, there are a number of older JUNO II's that were taken over from original ARPA assignments. One is scheduled to fly in May with a 100-pound IGY payload consisting of four different experiments.

Then there is one flight with a large 100-foot balloon developed by the NASA Center in Langley Field, and, of course, we have one more lunar probe to come in early 1959. And, one is a sphere whose mission has not been assigned yet. So the total is actually an even dozen.

In addition to these JUNO II flights, we have been invited by NASA to provide modified REDSTONES for the man-in-space program. The idea is that the capsule will be developed under a direct NASA-Langley contract, by a suitable capsule contractor who, I think, is scheduled to be selected in January.

These capsules will at first be tested, of course, in the laboratory, then will be subjected to one or two unmanned flights on the elongated REDSTONES, then to a few manned flights. Interspersed with these manned flights with the REDSTONE over 200-mile range will be some IRBM flights, probably unmanned, for which either JUPITERS or THORS will be used. And finally, the unmanned and, ultimately, the manned capsule will be put on top of an ATLAS to throw the capsule all the way into the orbit and return from the orbit.

Possibly, we will be called in to furnish a few JUPITER flights, two or three, for the 1500-mile range, but this issue hasn't been settled yet.

[REDACTED]

We believe the greatest contribution we can make in the long run to the NASA program will be the JUNO V (Chart 29).

The JUNO V is our name for a booster in the 1-1/2 million pound thrust class equipped with eight North American H-1 engines, which will ultimately have 188,000 pounds thrust each. Four of these engines will be rigid-mounted in the center; and four will be gimbal-mounted at the outside.

We had first proposed just to simply hinge-mount the outer engines so that two would control pitch, two would control yaw, and all four would control roll; but in order to supply sufficient control, it would be necessary to increase the throw of these engines to 10 or 11 degrees.

The engine contractor advised us, in the meantime, that this could possibly create some problems with the flex lines, and for that reason, suggested we go to a complete swiveling of all four engines, which would mean that we would deflect all four outer engines, all four for pitch and all four for yaw, and use all four of them also for roll.

We have selected swiveling of these four outer engines over just hinging in order to reduce the throw angle of the engines to 7 degrees, which is easily compatible with the flex lines. In other words, in order to pitch, we pitch all four outer engines; in order to yaw, we yaw all four. And this enables us to reduce substantially the throw, so this was finally selected.

The four inner engines are rigid-mounted.

Let me say a few words about the philosophy behind the whole thing. One is, of course, the pros and cons, or the relative merits of this multi-engine approach.

We believe very strongly that what goes for multi-engine safety in large airplanes can be applied to large rockets also, provided you retain an indisputable capability of continuing your flight under an engine-out condition. So this was the basic requirement in all our layouts.

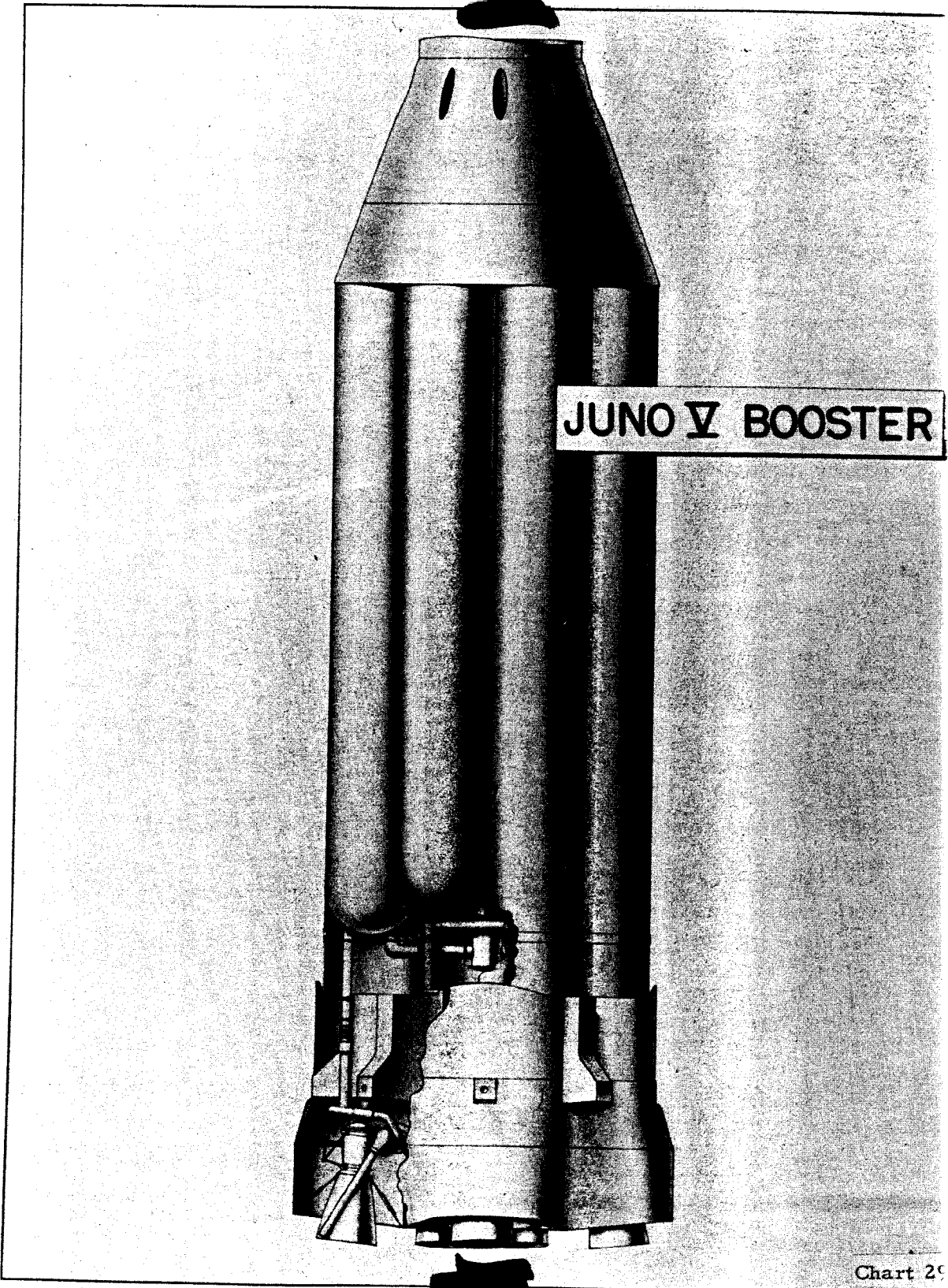

JUNO V BOOSTER

Chart 29

FILE NO 494 13875

[REDACTED]

We want to make sure - even in the area of maximum dynamic pressure - that we can continue the flight if one inner engine or one outer engine goes out. And with our four controlled, completely swiveled engines, this is assured.

In fact, with the exception of a 20-second duration, the period of maximum dynamic pressure during the first-stage flight, it should be possible to continue the flight with two of the outer engines out; and also, of course, with two of the inner engines out.

Now, another requirement other than controllability, and continued controllability, is, of course, that if you have a major mishap in the engine area, say a split pipe, you don't get a contagious fire in the tail. Each engine is in a separate compartment. Each engine is equipped with a simple fire extinguisher for that compartment, similar to an airplane engine. It has its own shut-off power so the supply of fuel and liquid oxygen for that particular compartment can be shut off upstream of the fire.

With these methods and with the electrical circuitry, we have reliable capability to continue the flight with an engine-out condition.

Let me add one more thing. For large vehicles like this, there is a great difference between aborting the mission and killing the crew. When you have an IRBM and ICBM not bringing the payload into the target, it is a flop.

There may be many cases where it is clear that the ship will have aborted the mission, but now you are faced with the mission of saving the lives of the crew, which may mean you have to continue the flight out into a thinner air where you can safely detach the top stages. Or you may want to continue the tilt to provide better re-entry conditions for the top stages and the like. So there will be emergency schedules for each second of flight. For example, what should be done in case you get an engine failure? Should you separate the top stage, continue with one engine out for a little while and then separate it, et cetera, et cetera? This capability is very definitely given.

[REDACTED]

Remember, also, that all these space vehicles that we have been talking about here, no matter how you build them, will be inherently aerodynamically unstable. With aerodynamic instability, we know that from our IRBM's and ICBM's, we are faced with the serious problem that if we have only one or two engines to live on and lose power, we lose not only the thrust to go upward, but we lose also the controllability. And, then, a missile, being aerodynamically unstable, will flip over. If it is in the high pressure region, it will simply fail structurally and you will have a fireball. For that reason, the capability of maintaining both power and controllability in case of limited failure is out.

Add to this the great advantage that will accrue to this scheme. Virtually thousands of tests have been run on this engine. The question really arises as to whether one will ever be able to match the reliability of such a system with anything you start developing from scratch.

Therefore, certain basic requirements are to be met to get full benefit of the multi-engine. You must retain the capability of emptying all the tanks if you have an engine-out condition.

If you have an engine-out condition, you wind up with a situation where you keep emptying three tanks and the fourth cannot be emptied; which means, of course, that you run out of trim and very soon you have to abort the mission and shut the other engines off, too, simply because the motors can no longer handle the torque.

It is for this reason that interconnecting lines are necessary between the tanks, and these are provided between the five lox tanks and the four fuel tanks, which make up the entire configuration.

Which brings me to the next question, why do we propose to cluster these tanks?

We don't do it just in order to use available tooling. We are doing it actually for two reasons. One is transportability.

By having a unit stacked together like this, as we propose, you can fly the inner tank section in a Globemaster airplane (Chart 30), and



FILE NO. 655-11 8 OCT 58

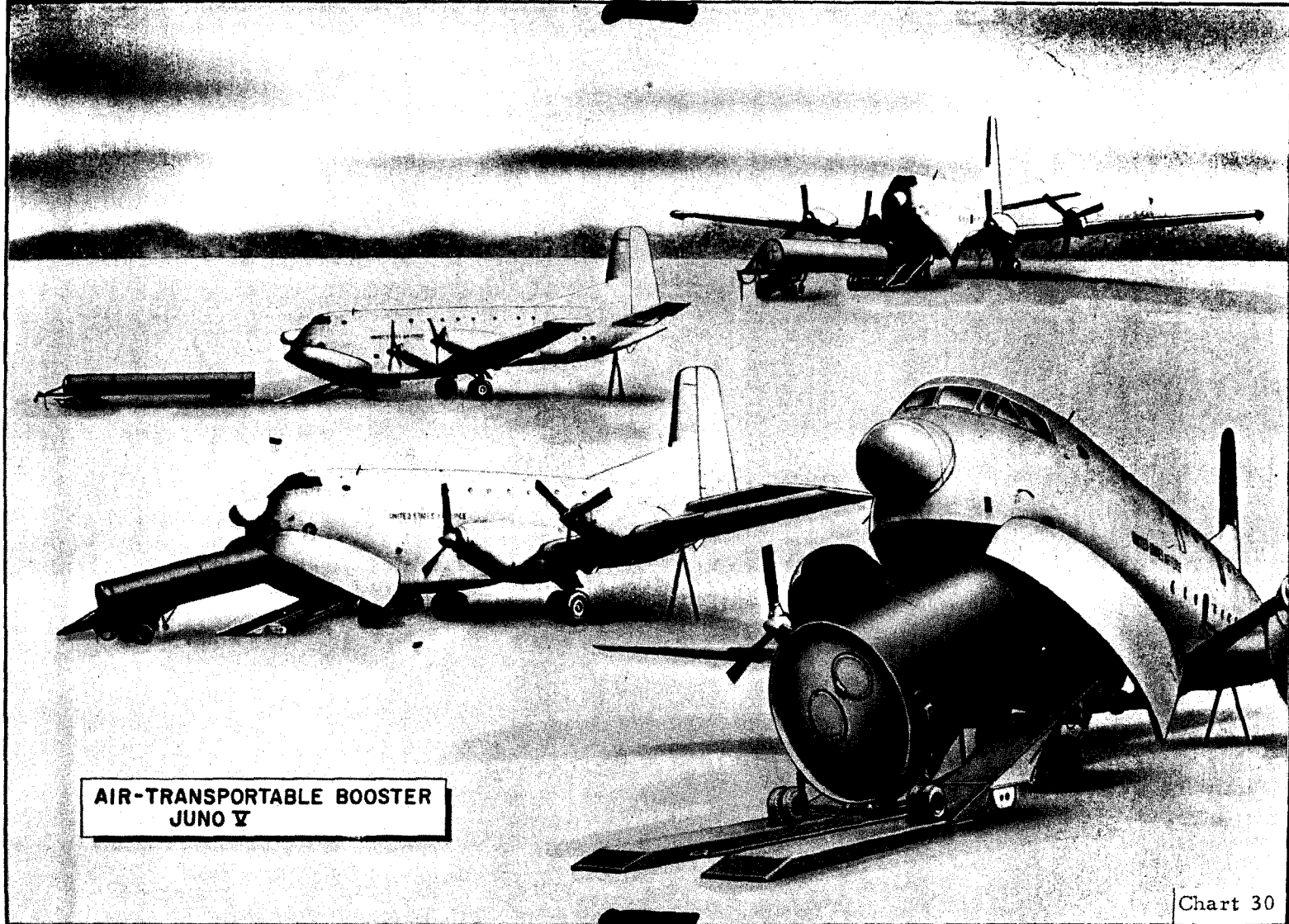

AIR-TRANSPORTABLE BOOSTER  
JUNO V

Chart 30

[REDACTED]

you can fly the outer sections in an airplane to any part of the globe, and put them together on the launching site.

We retain full air transportability, we retain roadability, shipability by train, without bothering about tunnel profiles, and the like. So we have full air, sea, road, and rail transportability ascertained.

However, there are other reasons behind it.

First and foremost is the question of weight.

These tanks have no center bulkheads at all. In other words, there is a top and bottom bulkhead, but there is no separation line in between.

Each tank is either entirely filled with fuel or with liquid oxygen. The way the tanks are split, the central tank is liquid oxygen, four outer tanks are liquid oxygen, and the four other outer tanks are fuel. This gives us the exact volume mixture ratio we need for JP and lox. And for that reason, we have tanks of equal lengths throughout, and tanks of equal diameter throughout, the inner tank being 105 inches in diameter, and all outer tanks 70 inches.

There are no bulkheads, no tube tunnels going through the tanks, and the like, so they are very easy to manufacture.

This also gives us a weight advantage. But, in addition to this, there is a question of sloshing baffles. We know from our JUPITER experience already that as we increase the tank diameter, we need sloshing baffles. And in the ATLAS, a very substantial weight had to be added for sloshing baffles after the original design was carried out.

These sloshing baffles, of course, have to be anchored to the outer tank structure also, which costs additional weight.

When you go to smaller tanks, you can do away with the sloshing baffles. Therefore, the absence of inner bulkheads and the absence of sloshing baffles leads to the conclusion that this is, at least, not heavier than a single tank, and probably lighter. So this is an additional advantage to all the others I have mentioned already.

[REDACTED]

This, then, is the basic JUNO V. The JUNO V gives you all kinds of capabilities. One capability is that in the future, it may also be used as a test bed for flight testing of single 1<sup>1</sup>/<sub>2</sub> million pound engines (schematic shown in Chart 31).

It will, of course, have a somewhat different thrust in this case, but we could still continue to provide the outer engines for controls and replace the four inner engines by a big one.

We feel very strongly that even if the 1<sup>1</sup>/<sub>2</sub> million pound thrust engine would ultimately be used, again in cluster form, to give you 6 million pounds thrust, or even more, it will definitely be necessary and desirable to subject it to some flight testing before you put it into a very large unit. And by that time, the JUNO V could be a well-proven unit and adapt itself quite readily to this.

It would look something like what is shown in Chart 32. Chart 33 deals with conceivable top stages. Now, we have been directed by ARPA to make a system study on what top stages could be used in connection with the JUNO V booster and when they might be available.

So this is my first thrust stage here at the top. However, the eight engines are presently 150K, but, in the future will be 188K with lox and RP, and will have a propellant capacity of 750,000 pounds of which, on certain missions, only 650,000 pounds will be used.

I can put on this booster essentially two types of top stages. One would be the conventional-type top stages. By that, I mean we would use conventional fuels.

Here, the simple solution would be to use the same engine, the 188K engine, uprated to 200K by attachment of a vacuum nozzle. That is, we would do the same thing that Rocketdyne did in the development of the ATLAS sustainer engine, or the same type of thing Aerojet does with the second stage of the TITAN.

With 180 to 200K pounds of thrust, it would then be a fine and suitable second stage. But, unfortunately, it couldn't be ready until 1962, because this requires some engine development which is not needed in this case.



JUNO V F1-H1  
COMBINATION

Chart 31

FILE NO. 707, 29. D.

FILE NO 655-6 8 OCT 58

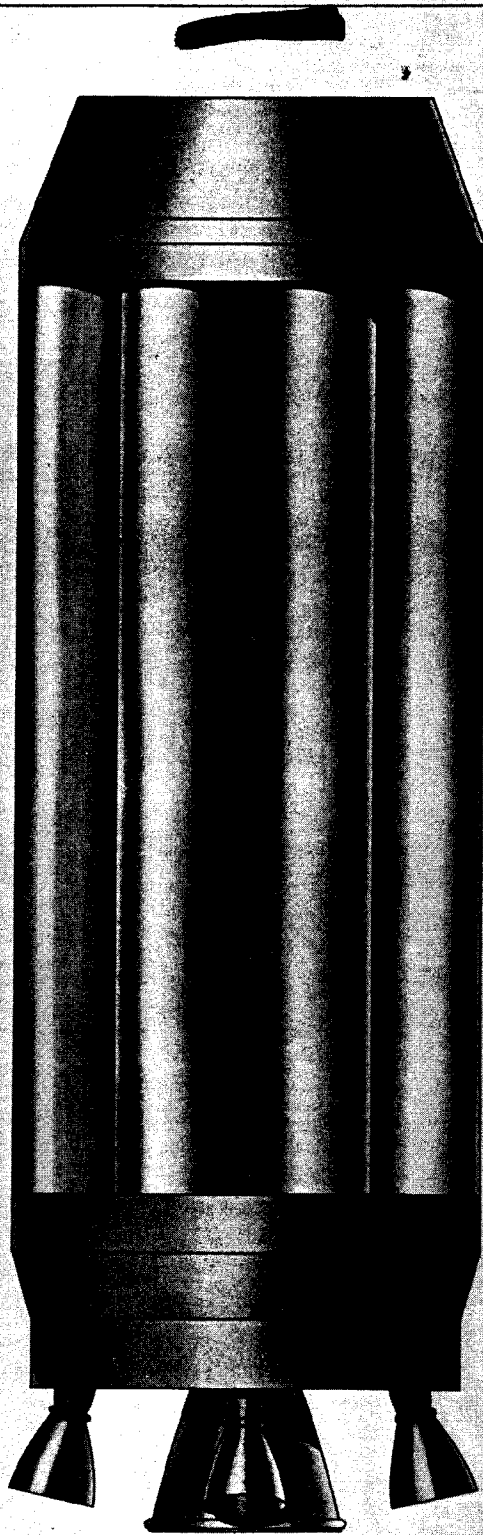

USE OF JUNO V BOOSTER AS TEST BED  
FOR 1.5 MILLION LB. SINGLE BARREL ENGINE

Chart 32

# JUNO V FAMILY TREE

## 1<sup>ST</sup> GENERATION (1960-1970)

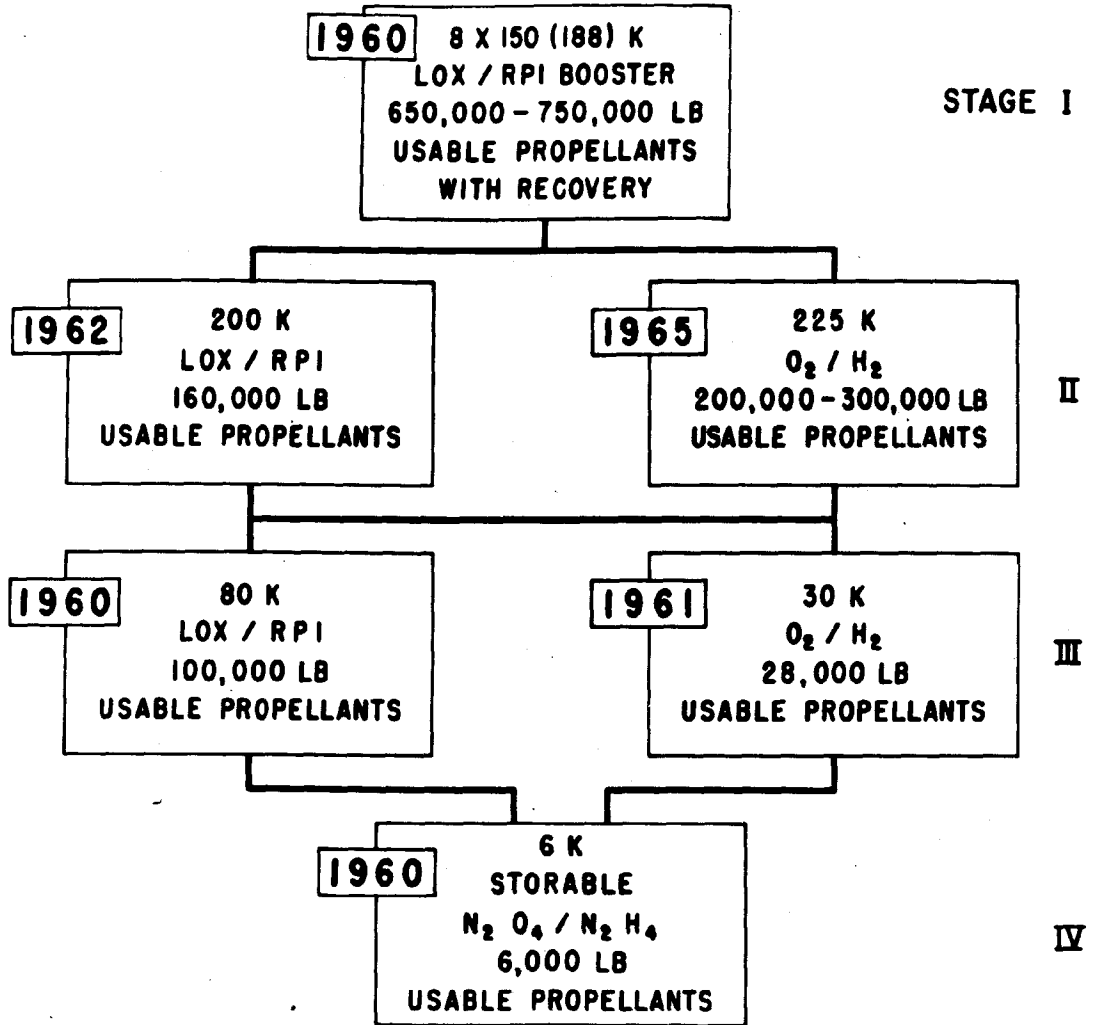

6 BUILDING BLOCKS WITH ALTERNATE 2<sup>ND</sup> AND 3<sup>RD</sup> STAGES  
WITH THE FOLLOWING MISSION CAPABILITIES:

- ① SHORT AND LONG RANGE SURFACE TO SURFACE MISSIONS.
- ② LOW, MEDIUM AND HIGH ORBIT ALTITUDE MISSIONS.
- ③ SPACE PROBES AND INTERPLANETARY PROBES.
- ④ LUNAR SATELLITE AND LANDING MISSIONS.
- ⑤ PLANETARY SATELLITE MISSIONS.

Chart 33  
FILE NO. 001 1 15 110V

[REDACTED]

I think we could get this one, an 80K engine faster and it would be an ideal third stage, but it could also be flown on the booster temporarily as a second stage.

This 80K engine would be either the present sustainer engine of the ATLAS, which is 75K, or the TITAN second stage engine. Both are developed for vacuum operation, and the TITAN engine has also been developed for vacuum ignition, but Rocketdyne assures us this would be no problem with the ATLAS engine either.

Of course, with space missions of precise orbits, such as 24-hour circular orbits, it would, in addition to that, be necessary to have a kick stage; and, in this area, we feel that the JPL 6,000-pound storable propellant engine burning  $N_2O_4$  and  $N_2H_4$  would be best suited in case high energy engines are not applicable for kick maneuvers.

This would also be a good engine for things like lunar soft landings, and the like.

For low orbits and very heavy payloads, it would not be so attractive, because, then, even the two-stage vehicle looks quite good, and certainly a three-stager would be enough.

With the JUNO V high energy propellants; however, we should go, and would like to go, into hydrogen-oxygen power plants for the top stages.

Here again, this one, the 30K Centaur engine, is actively under development, is coming along nicely, and should be available for flight testing in 1961; whereas, a big one, 225K, or even two of these presently only proposed by Rocketdyne might be available by 1964/65.

So time-wise, we can see that the 80K will be available earlier. So the first orbital capability will be by putting the 80K third stage on the JUNO V basic vehicle -- preferably, however, with a dummy of the second stage in between to simulate the proper ascent characteristics of the booster. This way, too, we would have only one aerodynamic configuration to worry about.

[REDACTED]

Then, in 1962, the second-stage engine could be available, giving us a full, all-out 25,000-pound orbital capability. And then, of course, we can replace the 80K with the 30K hydrogen stage giving us a little more payload capability. And in most cases, we would like to have the 6K for high altitude and escape missions.

This is the list of potential applications for the various configuration (Chart 33): short- and long-range surface-to-surface missions, which means ballistic transports; low-, medium-, and high-altitude orbital missions; space probes and interplanetary probes, lunar satellite and landing missions; and planetary satellite missions.

I have listed only the purposes here that are not ARPA's immediate applications for the JUNO V.

Chart 34 gives a typical multi-stage version of the JUNO V. Note we have limited ourselves here to the 120-inch caliber, which is presently the standard caliber of both the TITAN and the ATLAS.

The booster diameter would be 256 inches, and you can see from this drawing, without any further explanation that one may want to consider having at least for the second stage, a larger diameter.

It may be that the airframe re-design work involved in doing that would not be so great, because most of the work involves the engine and the controls anyway.

In this particular case, we have assumed a hypothetical TITAN I with one 200,000 pound thrust engine, with vacuum-type nozzle for the second stage. And we have assumed something like the ATLAS sustainer engine for the third stage. The fourth stage would consist of the JPL 6K with storable propellant and the guidance system. The payload compartment is shown at the top.

The fourth stage power plant would be so small on this diameter that it would preferably be mounted inside the instrument compartment so that the instrument compartment has sort of a doughnut shape. The engine would fit inside and could be pulled out for access.

Chart 35 shows JUNO V payload capability for selected space missions. This shows the distances for these various missions, flight



# JUNO V VEHICLE

STANDARD FIRST GENERATION

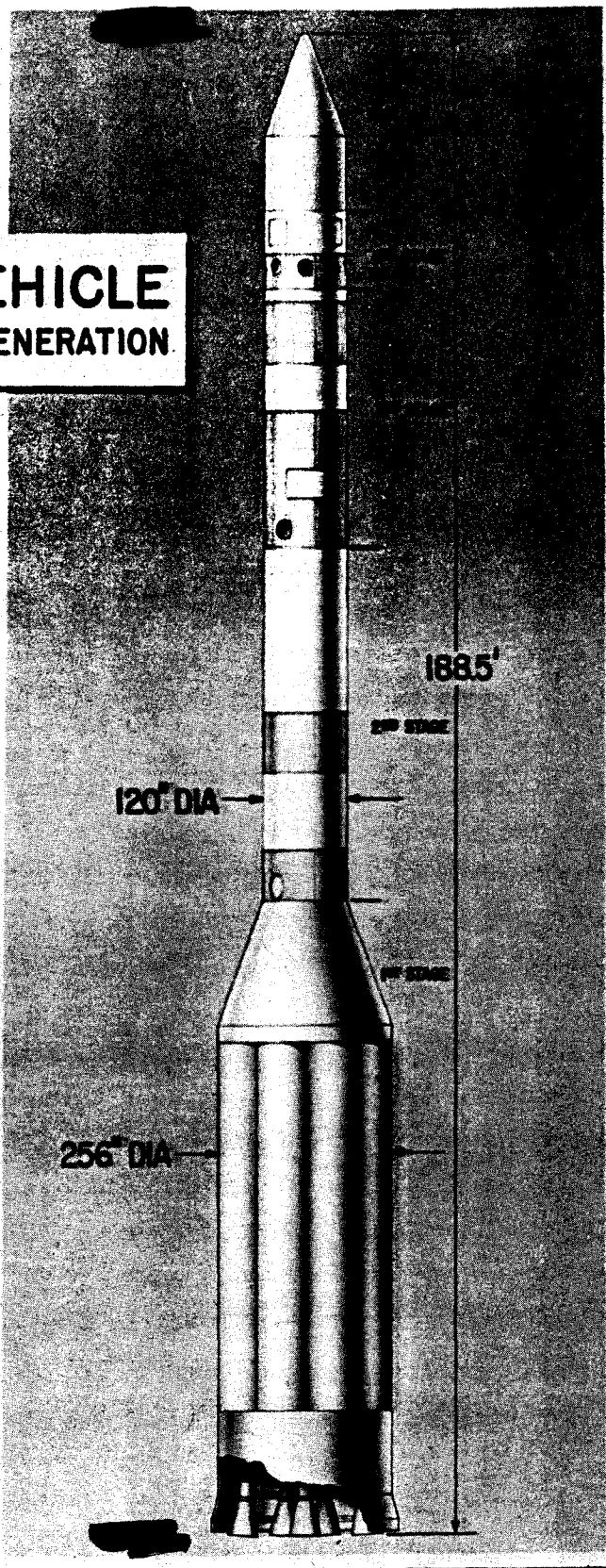

Chart 34

FILE NO 68-1  
13 NOV 58

## PRELIMINARY ESTIMATES OF JUNO V PAYLOAD CAPABILITY FOR SELECTED SPACE MISSIONS

MISSION	DISTANCE (km)	FLIGHT TIME (Days)	TOTAL MISSION VELOCITY REQUIREMENT (km/sec)	GROSS PAYLOAD (lb.)		
				3-STAGE	4-STAGE	5-STAGE *
SPACE PROBE	$5 \times 10^4$ TO $1 \times 10^9$	1 TO 4000	12.5 TO 16.5	7500 TO 600	7500 TO 1300	
LUNAR PROBE	$4 \times 10^5$	1.5 TO 5	12.1	8700		
LUNAR CIRCUMNAVIGATION	$4 \times 10^5$	2 TO 8	12.5	7500	7500	
LUNAR CIRCUMNAVIGATION AND RETURN	$4 \times 10^5$	10 TO 12	12.6	7200	7200	
LUNAR SATELLITE	$4 \times 10^5$	<u>1.5 TO 5</u> PLUS LIFETIME	12.8	6800	6700	
LUNAR SOFT LANDING	$4 \times 10^5$	<u>1.5 TO 5</u>	15.5	1800	2100	
LUNAR SOFT LANDING AND RETURN	$4 \times 10^5$	3 TO 10 PLUS STAY TIME	19		60	475
MARS PROBE	$4 \times 10^8$	260	12.7	7100	7000	
VENUS PROBE	$2.6 \times 10^8$	146	12.7	7100	7000	
MARS SATELLITE	$4 \times 10^8$	260 PLUS LIFETIME	15.5	1800	2200	
VENUS SATELLITE	$2.6 \times 10^8$	146 PLUS LIFETIME	16	1200	1700	

\* ASSUMING SOLID PROPELLANT LAST STAGE FOR RETURN

[REDACTED]

time in days, and velocity requirements in kilometers per second.

You can see from the last columns that there is always an option of using either three stages or four stages; and, in some cases, there is not even a payload gain by going to four stages. But the problem is you may need the fourth stage for two reasons: (1) for navigations and corrections; and (2) to avoid the nasty restart problem of the same engine.

We feel very strongly that, for many space missions, particularly for the deeper space missions, it may be advantageous to have four stages.

Now, one possibility that will, of course, arise -- and this, as Mr. Koelle pointed out, is a very essential part of an over-all space program -- is that somehow as a result of NASA space cabin development in connection with ATLAS and SUPER-ATLAS, there will be a need for a capability of carrying more than one person into orbit for purposes of personnel rotation. This is shown just as a sketch on Chart 36. The idea here would be that on top of the multi-stage vehicle, using the stages just mentioned here, will be this capsule arrangement. And the capsule will be essentially a cone, which can be flatter or deeper, fashioned after the present Langley philosophy of building the re-entry nose cone. It has one engine to pull the nose cone out of the orbit and back into a transfer ellipse whose perigee will go into the atmosphere. And it also has on top here some solid rockets for fast breakaway from the ship in case of trouble during the ascent.

These rockets, then, correspond to what sits on top of the derrick at the moment on the capsule; whereas, this one is the return capsule.

Now, inside this cone, there would be room and weight capability for no less than 16 people (Chart 37).

Now, this is nothing but an artist's conception. It merely shows what we consider to be a logical extrapolation of the present NASA capsule design and what kind of thing one would get if one were to mate

REGARDED CONFIDENT  
3 YEARS FROM  
DATE OF THIS CHAP

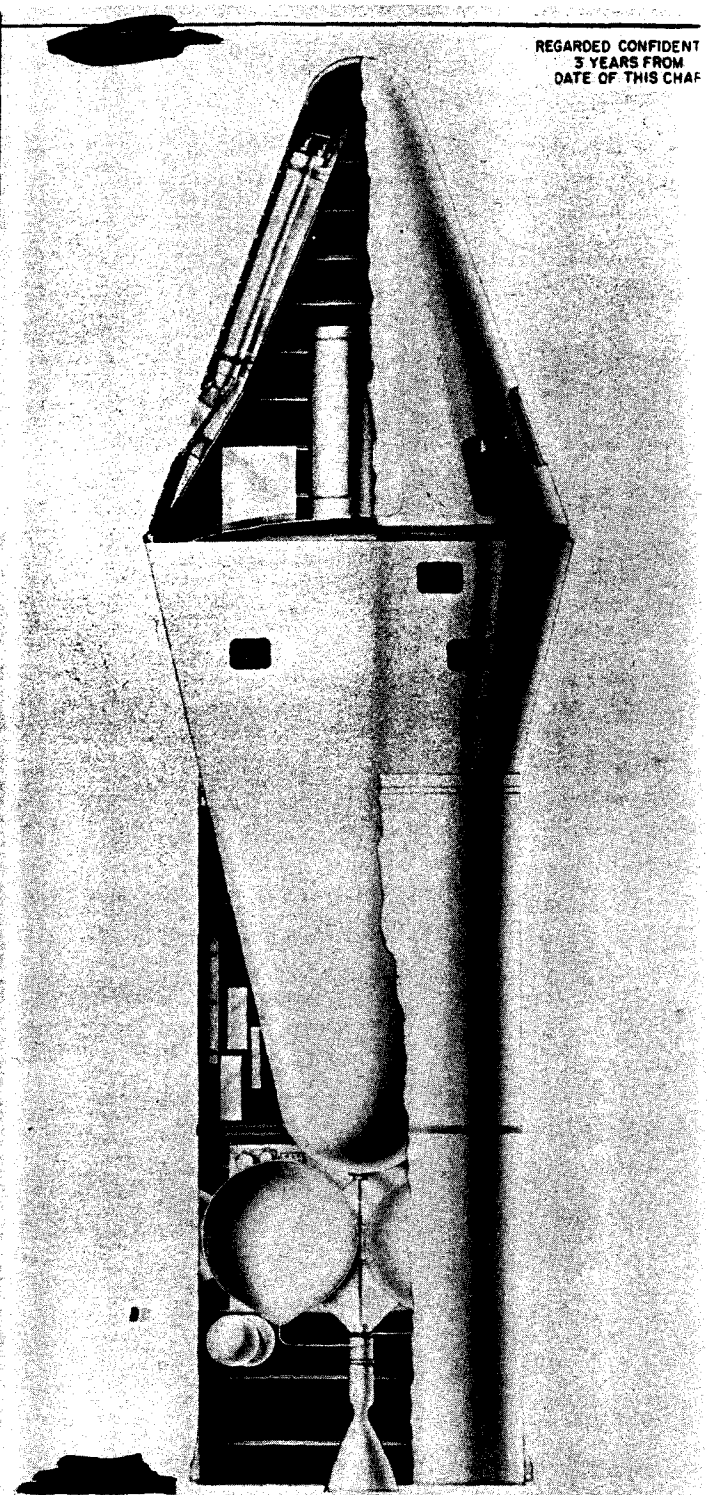

**ORBITAL RETURN VEHICLE**  
**(16-MAN CARRIER)** Chart 36

FILE NO. 703-1 12 DEC 51

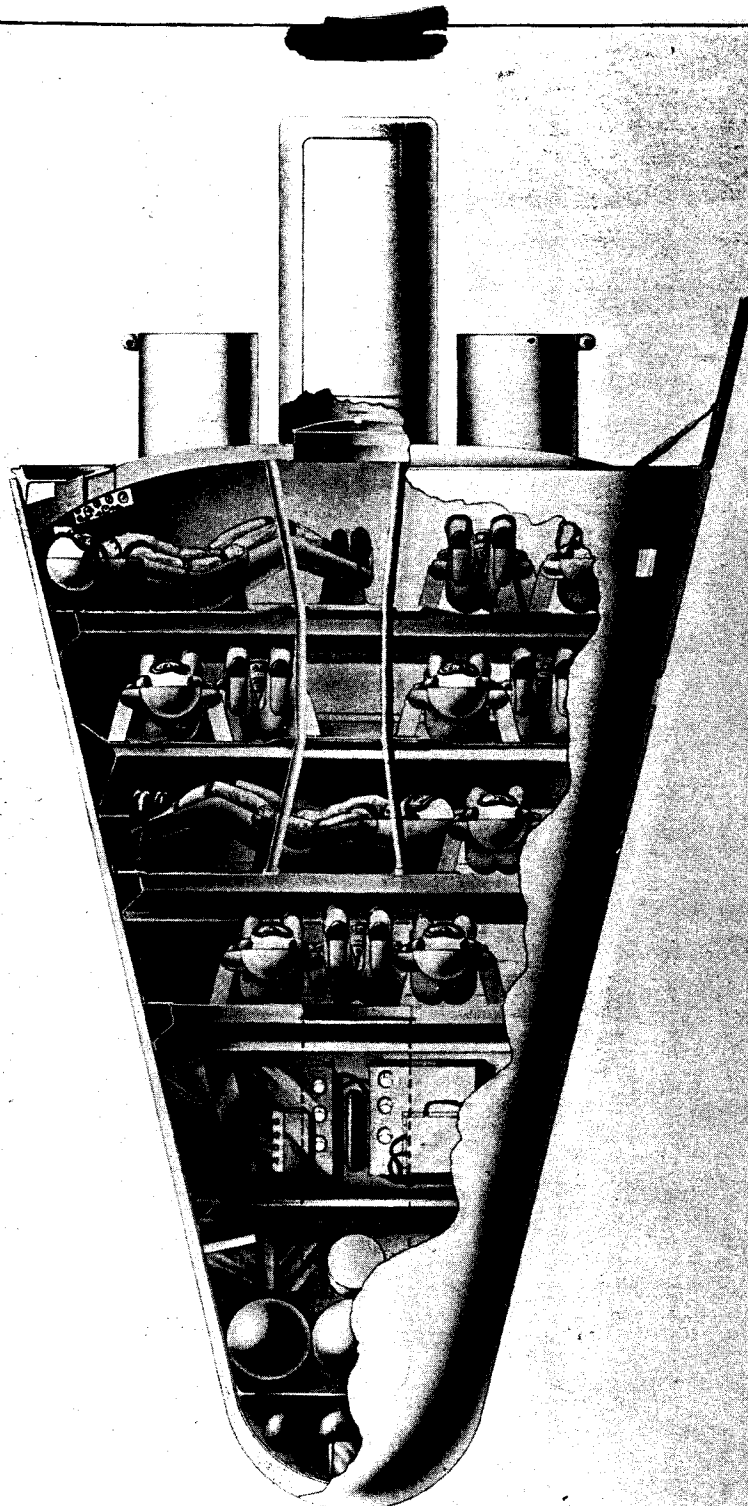

**16-MAN CARRIER  
(ORBITAL RETURN VEHICLE)**

Chart 37

FILE NO 703-2 12 DEC 58

it with the payload-carrying capability of the JUNO V. As I indicated, there is room for 16 people in the capsule. The arrangement would be just as it is in the present capsule. There would be parachute containers and an air lock for the men.

All kinds of gear for altitude control and the like are also included.

The next group of charts will describe our assembly operation. Chart 38 shows a cross section of our main fabrication building at ABMA, just to illustrate how the JUNO V fits into our existing hangar.

You see the available space is entirely sufficient to mount the eight tanks around the center tank. There are areas for the preparation of the outer tanks, inner tank, and instrument compartment.

Chart 39 is another breakdown of our assembly hangar. It shows how we are presently implementing the existing ARPA contract.

Most of you are familiar with our main assembly hangar and will recognize the main entrance and the pressure test booth. We have designated the areas indicated for assembly of boosters, and inner sections. The residual JUPITER work has been pushed over into one corner because it will be phasing out before long.

The engines will be prepared in another rather sizeable area. When you have eight engines, it takes floor space.

The next charts show, in essence, how we are planning to go about the assembly of the JUNO V's.

The section shown in Chart 40 is a corrugated section 105 inches in diameter, which sits beneath the central liquid oxygen tank. It is the main thrust element in which the thrust of the main engine is carried into the total unit.

The outrigger carries the engines, the four mounting points for the rigid inner engines and the four for the swiveled outer engines are shown clearly.

This is how the thrust frame is aligned.

After the thrust frame has been built, it is mounted on a jig (Chart 41), and it is bolted to the liquid oxygen tank here at this mounting ring at the aft end of the tanks. The ring with the cables is just a

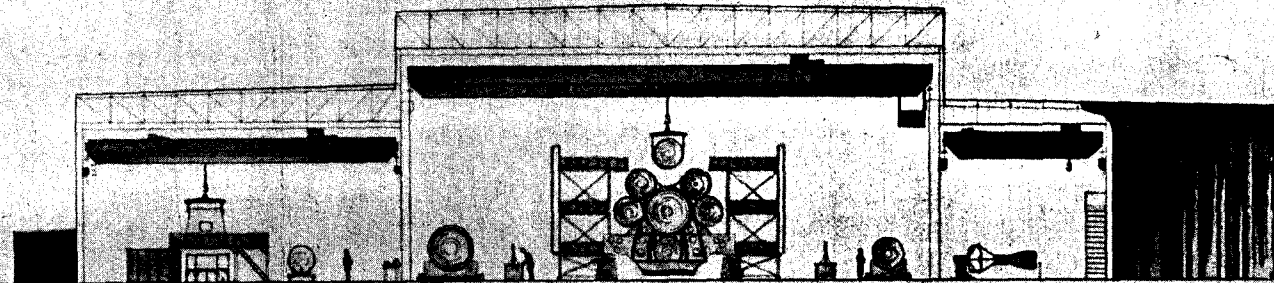

CROSS SECTION MAIN ASSEMBLY BUILDING

PREPARED BY  
NATIONAL COMMISSION ON  
PLANT AND EQUIPMENT  
TRANSPORTATION, STORAGE AND MAINTENANCE

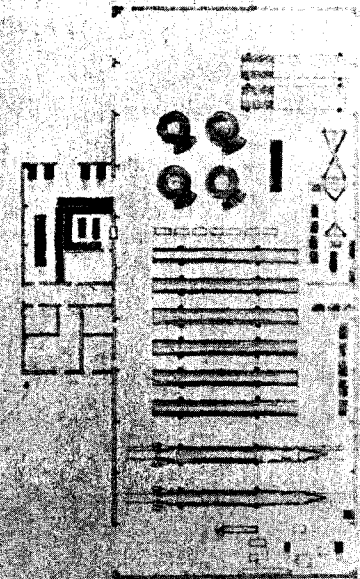
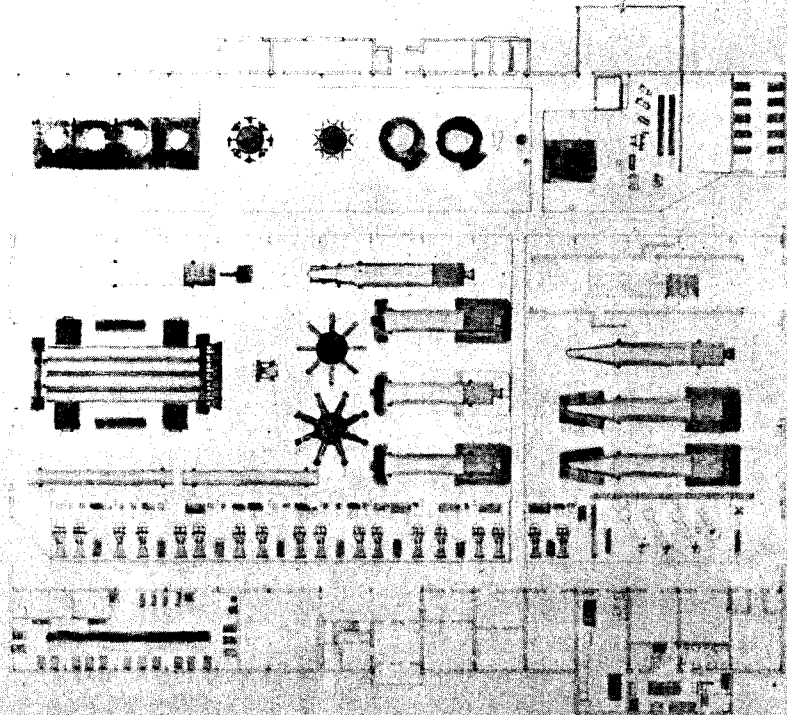

FLOOR PLAN MAIN ASSEMBLY BUILDING 4705

4706



THRUST FRAME ASSEMBLY AND ALIGNMENT FIXTURE



Chart 40

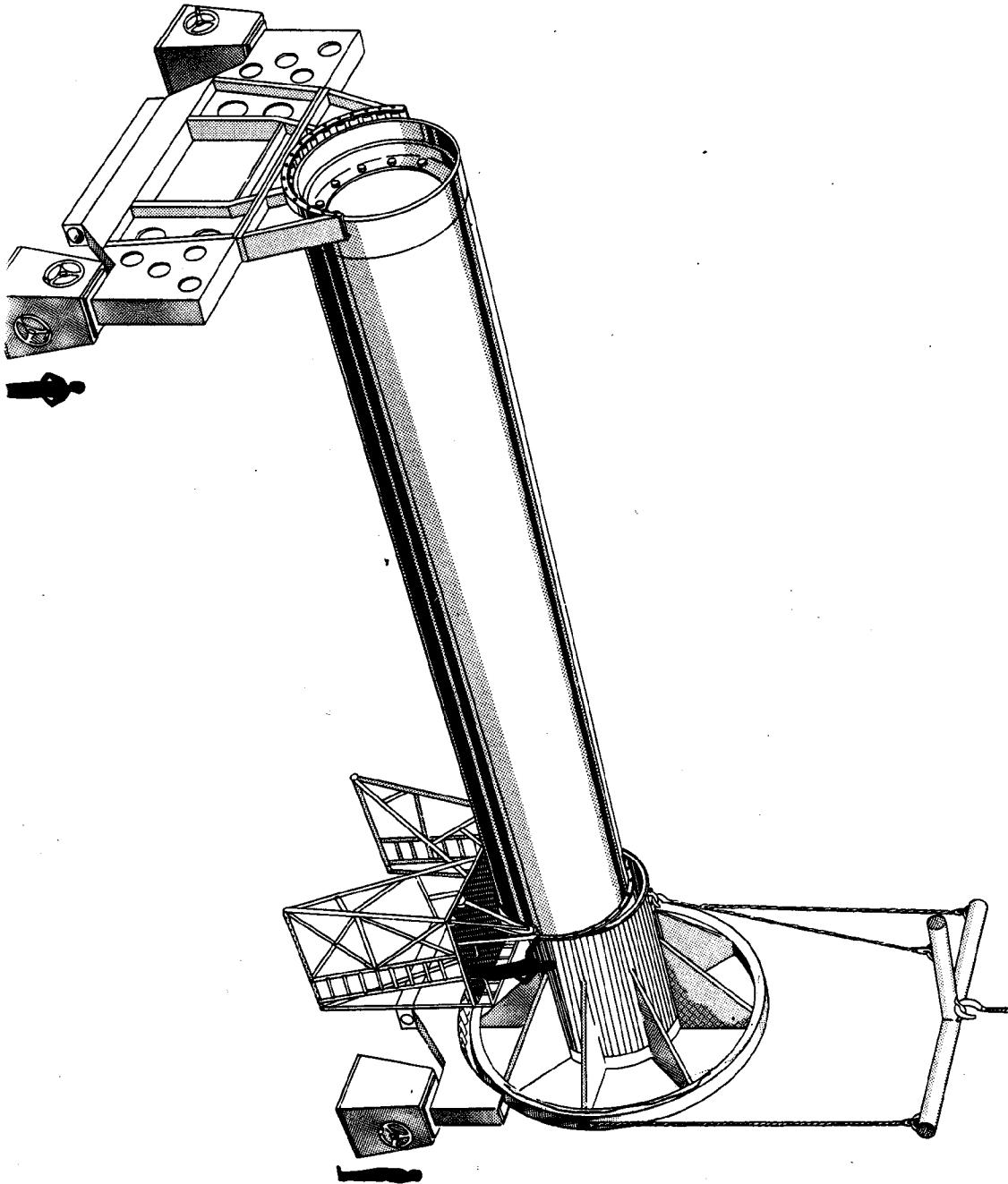

MAIN CLUSTER FINAL ASSEMBLY FIXTURE  
PHASE I

[REDACTED]

support in the jig and does not remain attached.

After this, a ring is attached to the forward section of the long tank as shown in Chart 42. This will be the berth for the eight outer tanks.

I would like to mention in this connection that it is the liquid oxygen tank, the central one, plus the four outer liquid oxygen tanks - which carry a pretty high pressure anyway to prevent cavitation - which carry the main load for the thrust to the upper stages.

Liquid oxygen tanks, of course, contract under the low temperature; whereas, the fuel tanks do not. And for that reason, we have to allow for a certain amount of shrinkage between the fuel and the lox tanks. This may rule out the feasibility of using the fuel tanks to carry the load through the missile.

Analyzing this, we find that the lox tanks need the higher pressure anyway; it is kind of a pressure that carries the load. It is a kind of pre-stressed tank, as it goes up under the high acceleration.

The whole thing looks quite sound structurally.

Chart 43 shows a continuation of the assembly process. At the aft end, you see the shrouds attached for the four outer engines. As in the case of the ATLAS, we found it necessary to surround the outer engines by shrouds so that as the engine is deflected outside, it will not be hit by a supersonic jet stream which would build up excessive deflection torques; and in addition to this, an undue load on these very flimsy, spaghetti-type nozzles.

The whole unit, of course, can be rotated on the assembly fixture.

Once it has been assembled, the unit will be loaded on the transporter shown in Chart 44 and carried to the test stand, or wherever you want to take it for testing.

It is at this point, of course, that we are faced with a clearance problem. But, fortunately at Redstone Arsenal, we have no such problem, as will be brought out later.

MAIN CLUSTER FINAL ASSEMBLY FIXTURE  
PHASE II

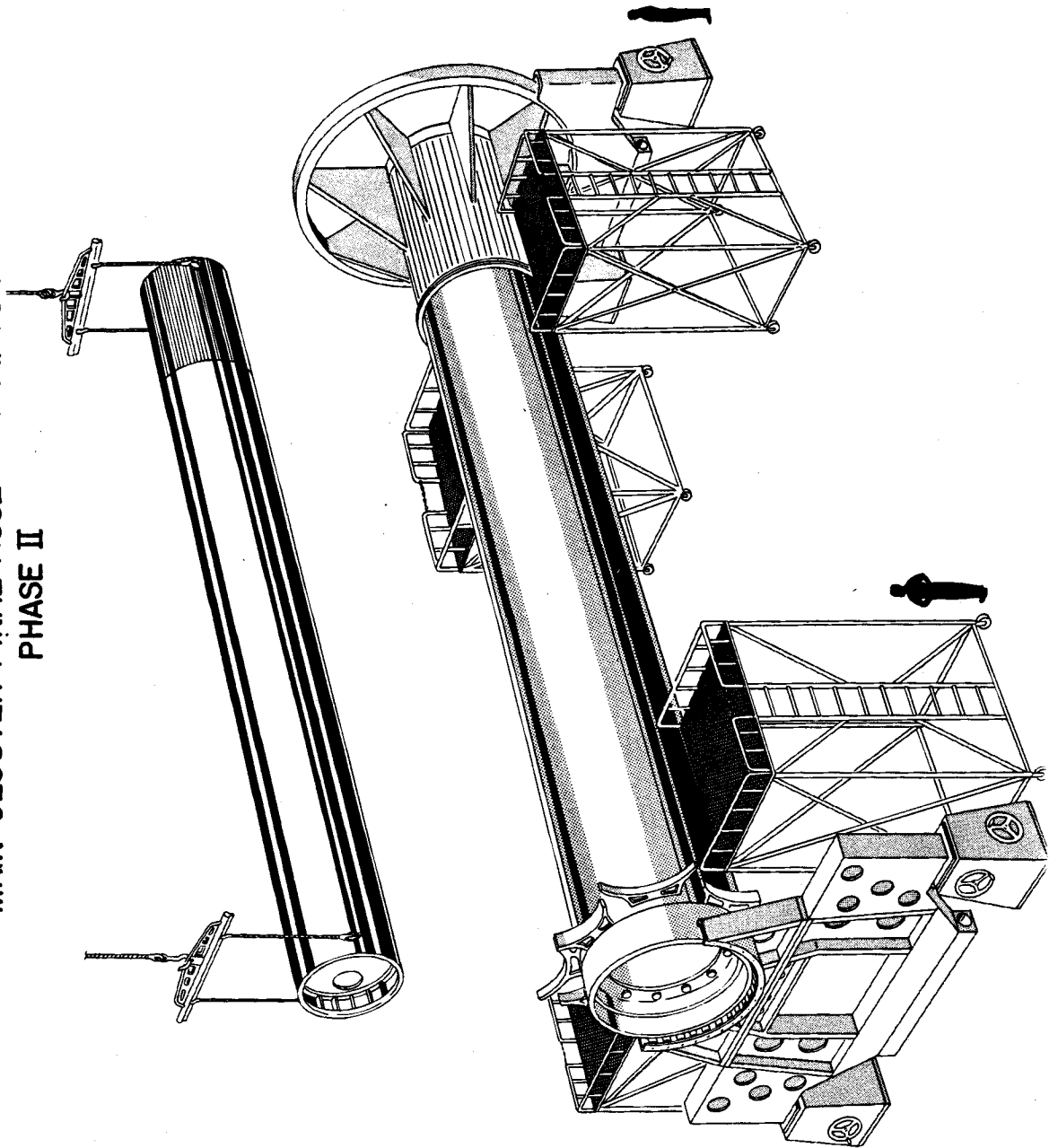

MAIN CLUSTER FINAL ASSEMBLY FIXTURE  
PHASE III

88

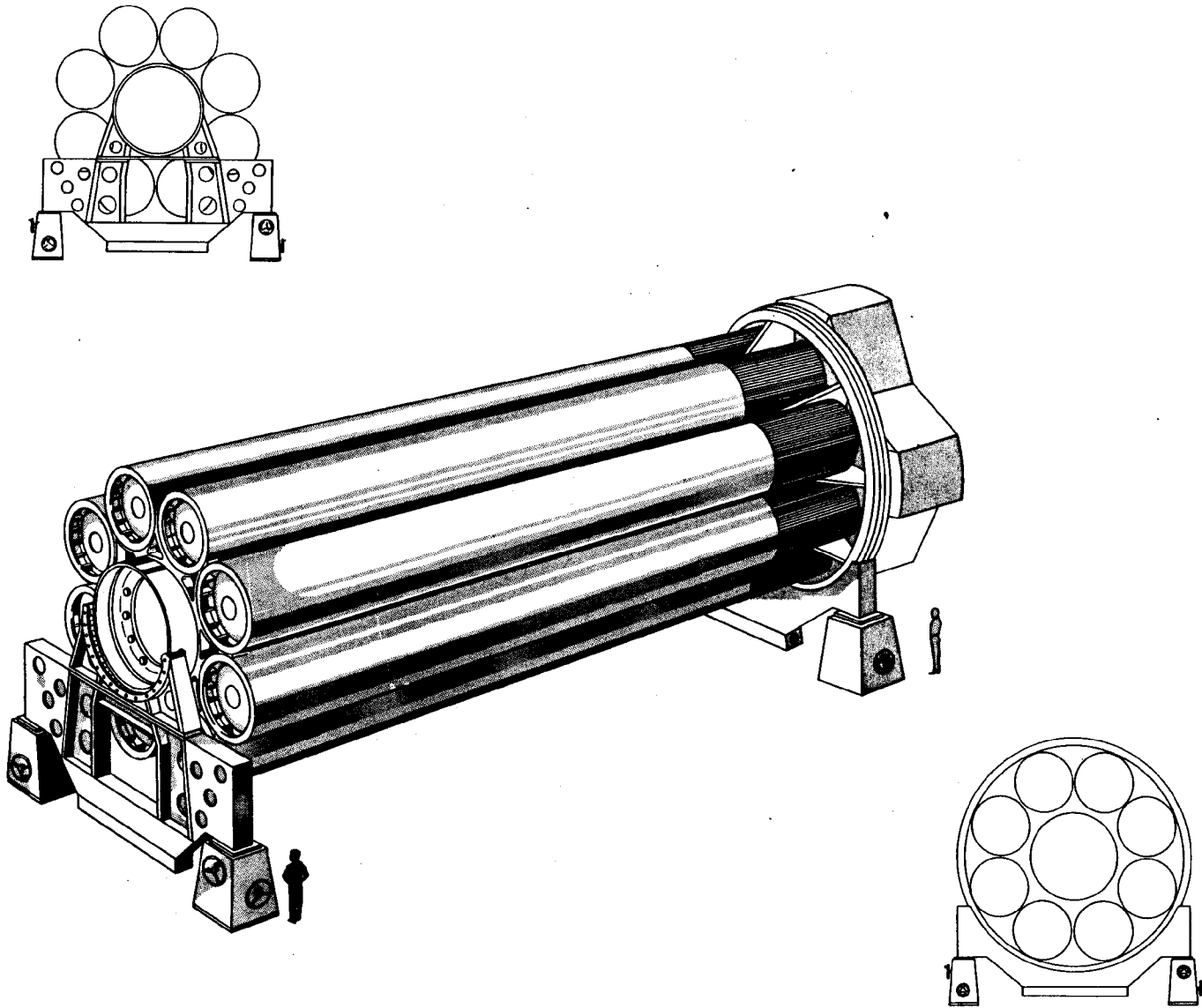
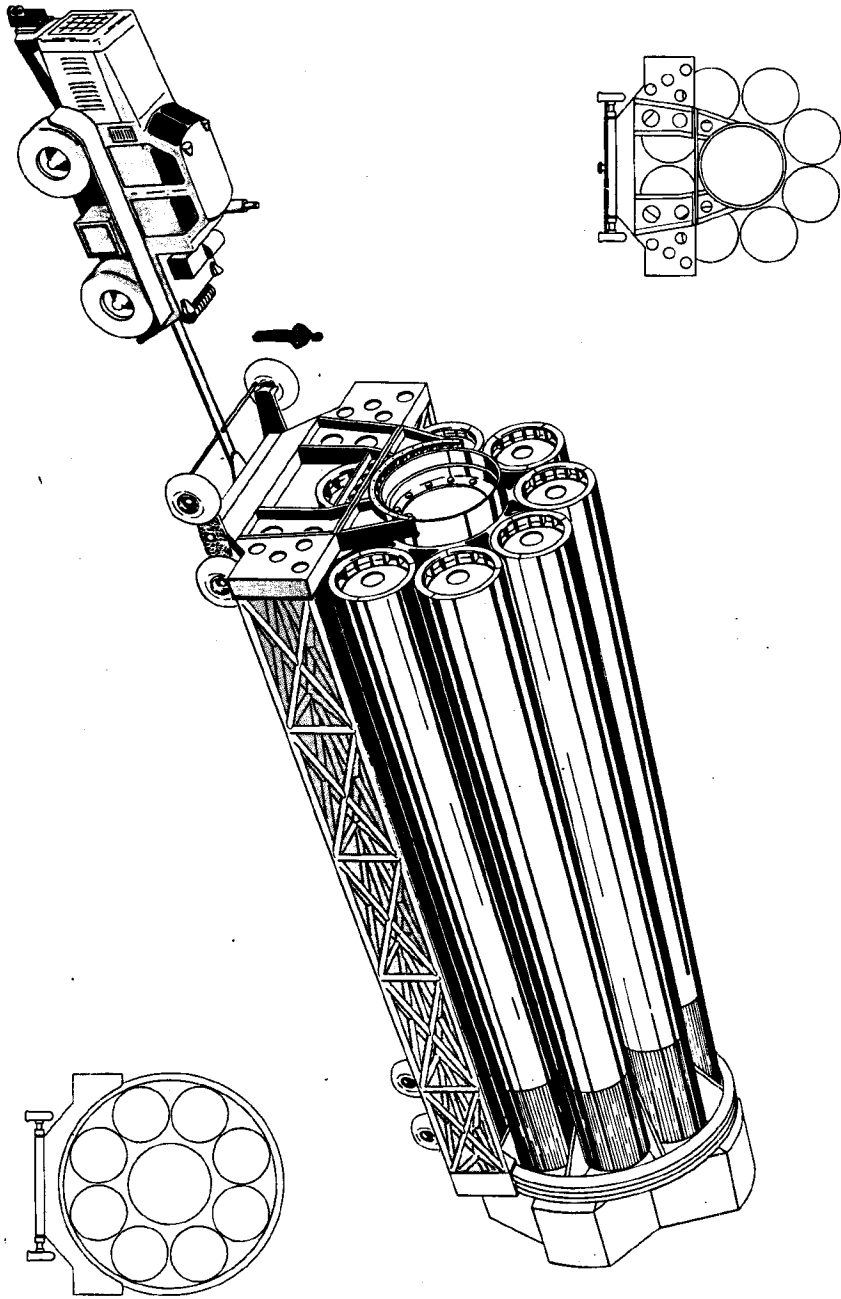

Chart 43



MAIN CLUSTER FINAL ASSEMBLY FIXTURE  
PHASE IV

[REDACTED]

The test stand modification, which has also been approved and budgeted by ARPA, is shown in Chart 45.

You remember the JUPITER test tower, where we usually fired one JUPITER on either side.

Under this modification, a kind of bridge structure will be added on top; two beams will be added; and we have these built-in rails in the tower which will allow us to adjust the servicing platforms to all stations.

It was further found necessary to build reinforcements to take some of the load off the foundation and to provide some side walls for the jet projection. Otherwise, there was danger of some spill-over from the fire, if the engines were deflected. This would damage the concrete.

The crane, of course, is in existence and will be used to mount the entire booster in its place.

Just for comparison, the JUPITER is shown in Chart 45 which is a photograph of a model we built.

Chart 46 shows the JUNO V in a little more detail. You see the engines sticking out here. It is very easily serviceable from all sides.

I would like to mention one more thing in connection with these engines. The outer engines would be canted 6 degrees, the inner engines only 3 degrees. It turned out this is advantageous for continuation of the flight with a one engine-out condition. You can easily see that if the thrust goes to the center of gravity, there is something to be gained.

However, for take-off, it is not so advantageous to have the jet spreading out like this, because you sweep fire over your launching table. In addition to this, there is a substantial shift of the center of gravity during the flight.

Now, our control people have analyzed this and come up with a very simple suggestion. Since we have a control computer anyway, nothing is simpler than to inject an electrical bias into that control computer, which would pull the engines together for take-off. Then

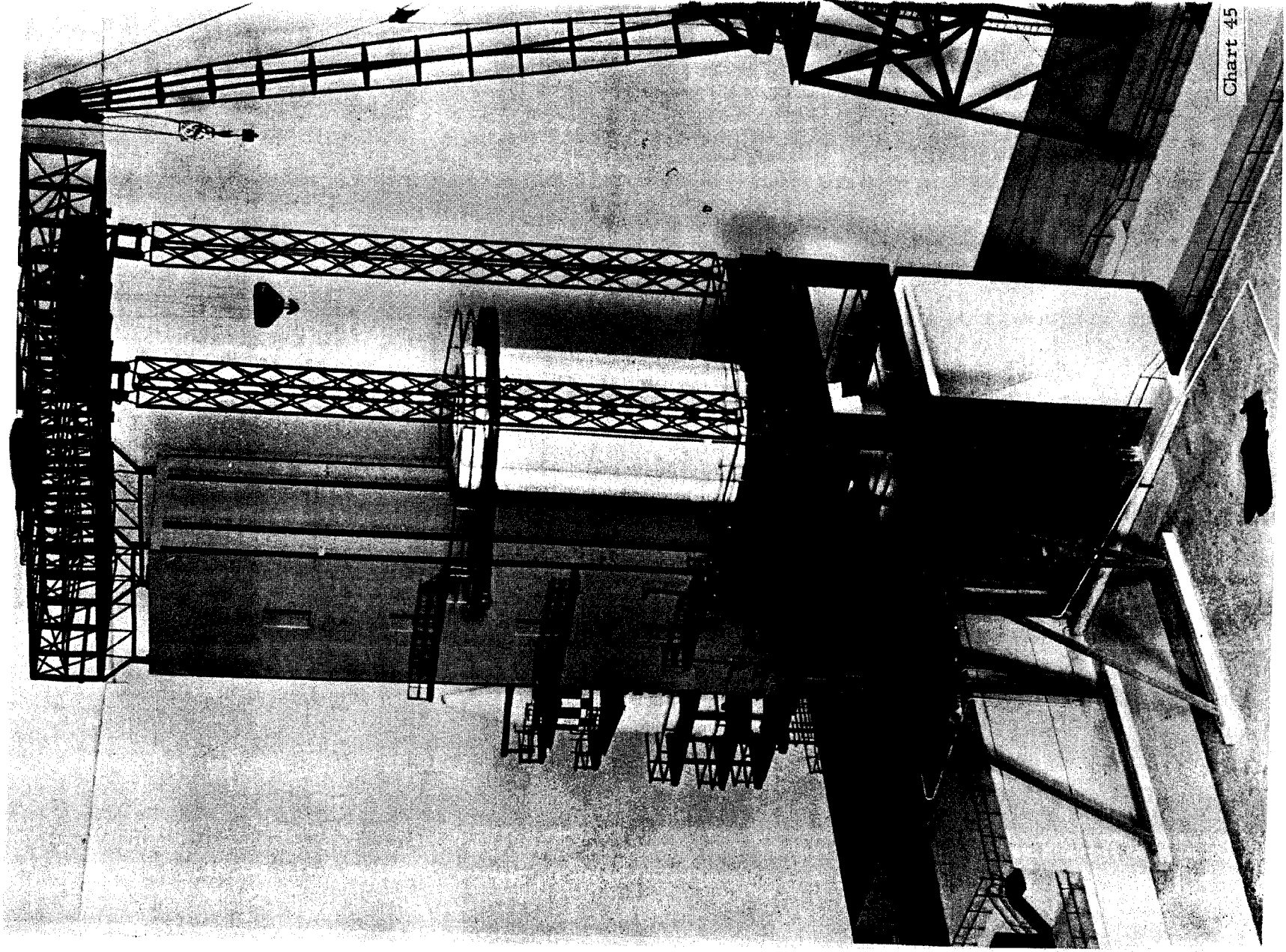
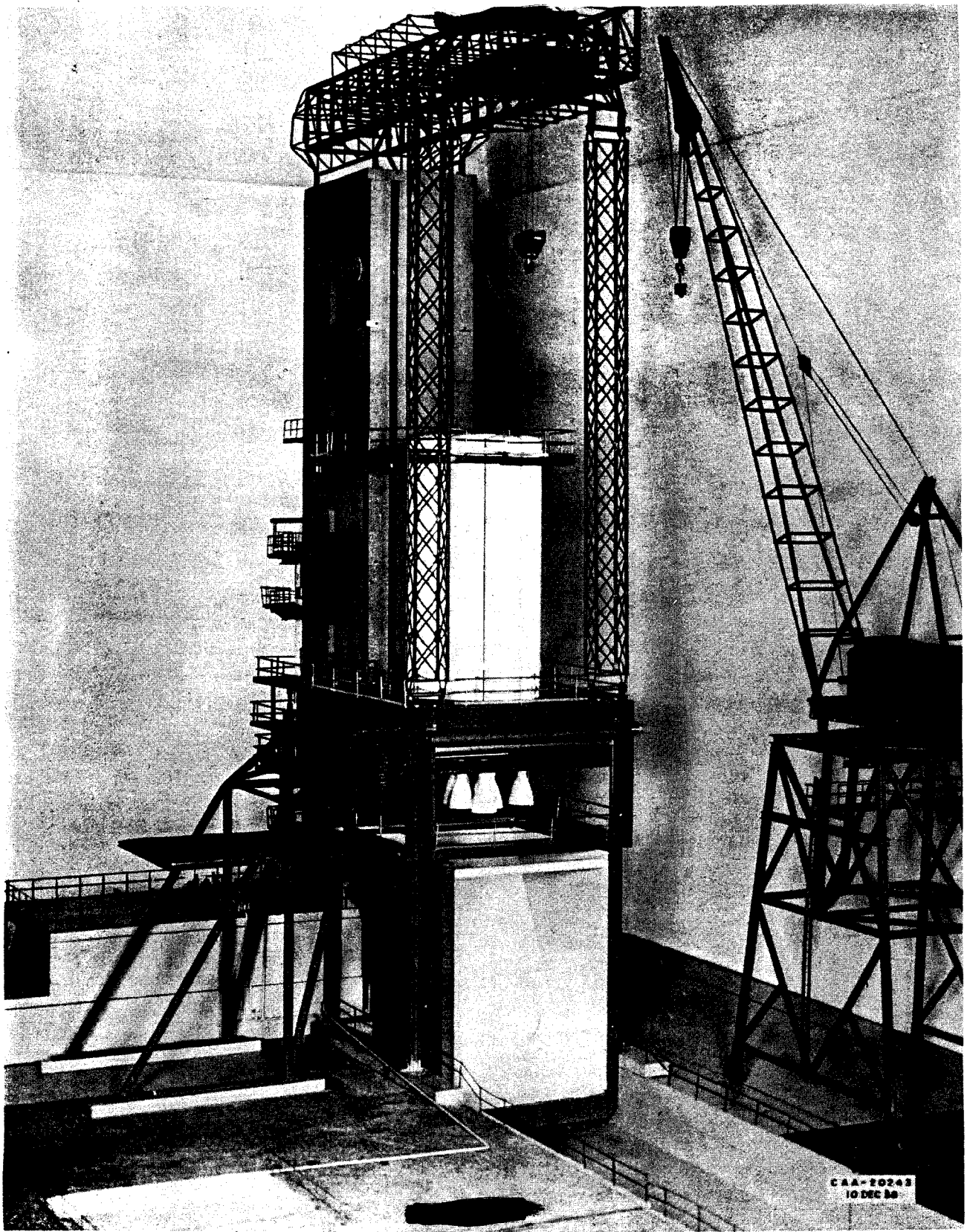



Chart 45







3 seconds after take-off, the cant bias is taken out; the engines spread out; and you fly with the canted engines. And, even as the CG travels, you can adjust the zero position of the cants slightly. And then shortly before cutoff, you point the engine axis exactly to the local center of gravity so that if you get an uneven cutoff there will be no residual torque to interfere with the separation of the next stage.

This is a very simple electrical procedure which would not even be visible from the outside. It is simply a little circuitry in the control computer.

For testing on the test stand, we would propose under normal circumstances, in order to save the chutes, to leave the engines parallel.

Chart 30 shows the philosophy of transporting such a unit overseas. For example, if you want to fire lunar vehicles from a Pacific island; and, you are in a hurry, you can fly the individual tanks out there and put them together again.

Now, while this is entirely feasible -- and I think there can hardly be any question that this can be done, because if you can assemble this unit in a hangar in Huntsville, there is no reason why you cannot assemble it on an island in the Pacific. It would be necessary to make a pressure test and checkout afterwards and you would need personnel and facilities, but what you can do in Huntsville, you can do anywhere else. However, in a low density firing program, it may be a question of economy as to whether you would want to do it right from the beginning.

For that reason, we have investigated the possibility of also shipping these complete boosters from Huntsville to Cape Canaveral during the early R&D phase, simply to save personnel and equipment. This is actually possible.

We will take this little road transporter you saw in Chart 44, tow our booster to the Tennessee River dock on Redstone Arsenal, put

the thing on a barge, and tug it down the Tennessee-Ohio-Mississippi to New Orleans. At New Orleans, we will put the booster on a sea-going vessel, probably an LSD, which will then take it around Florida into the Cape Canaveral harbor (Chart 47). From Cape Canaveral, it will be put on the road again, and the transporter will take it directly to the launching pad.

The total duration of this trip, estimated by the U. S. Army Transportation Corps, will be 13 days. So while it certainly is a consideration in the schedule, it may be cheaper and more convenient to do it this way than ordering all our check-out equipment twice, and either bringing our assembly people to Cape Canaveral to re-assemble it or have another crew stationed there to assemble it. For low density operations, it is certainly possible to use this plan.

Chart 48 shows a result of a study of our inner arsenal transportation to the Tennessee River dock, and we found that all we have to do is strengthen one low bridge over the Wheeler Reservoir a little bit to get it across.

Chart 49 - which is still very tentative - shows a conceivable plan for an early firing facility at Cape Canaveral, but it has not attained final blessing yet. The idea behind this was the following. In the northern area of Cape Canaveral, the western-most ICBM launching station, very close to the road that goes up to Smyrna Beach and on to Daytona, is the so-called TITAN launching pad, VL-20. This was built along with all the rest of them and has been completed to the point that the blockhouse is ready and the concrete work in the launching facility itself is ready. But at this point, the construction work on the facility has been discontinued, I think for budgetary reasons or because it is felt that the other facilities will do.

The idea is now to activate this existing blockhouse and build a JUNO V launching pad adjacent to it.

The advantage is that not only the blockhouse is there, but there is power; there is water; there is telephone; and there are a certain number of roads available. In addition to this, there is some

# JUNO V BOOSTER TRANSPORTATION

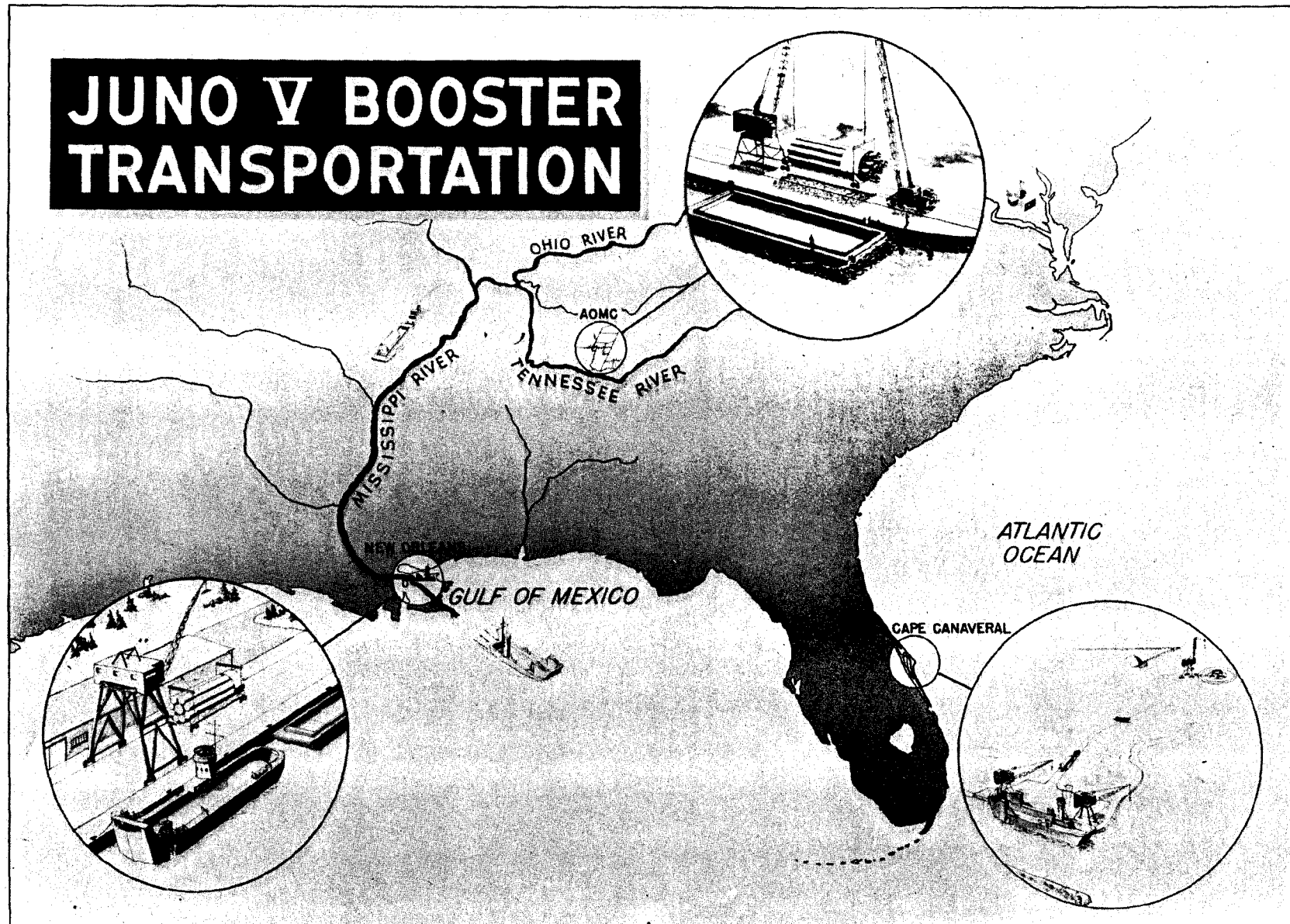

# ROUTE MODIFICATION (FABRICATION BLDG. TO RIVER DOCK)

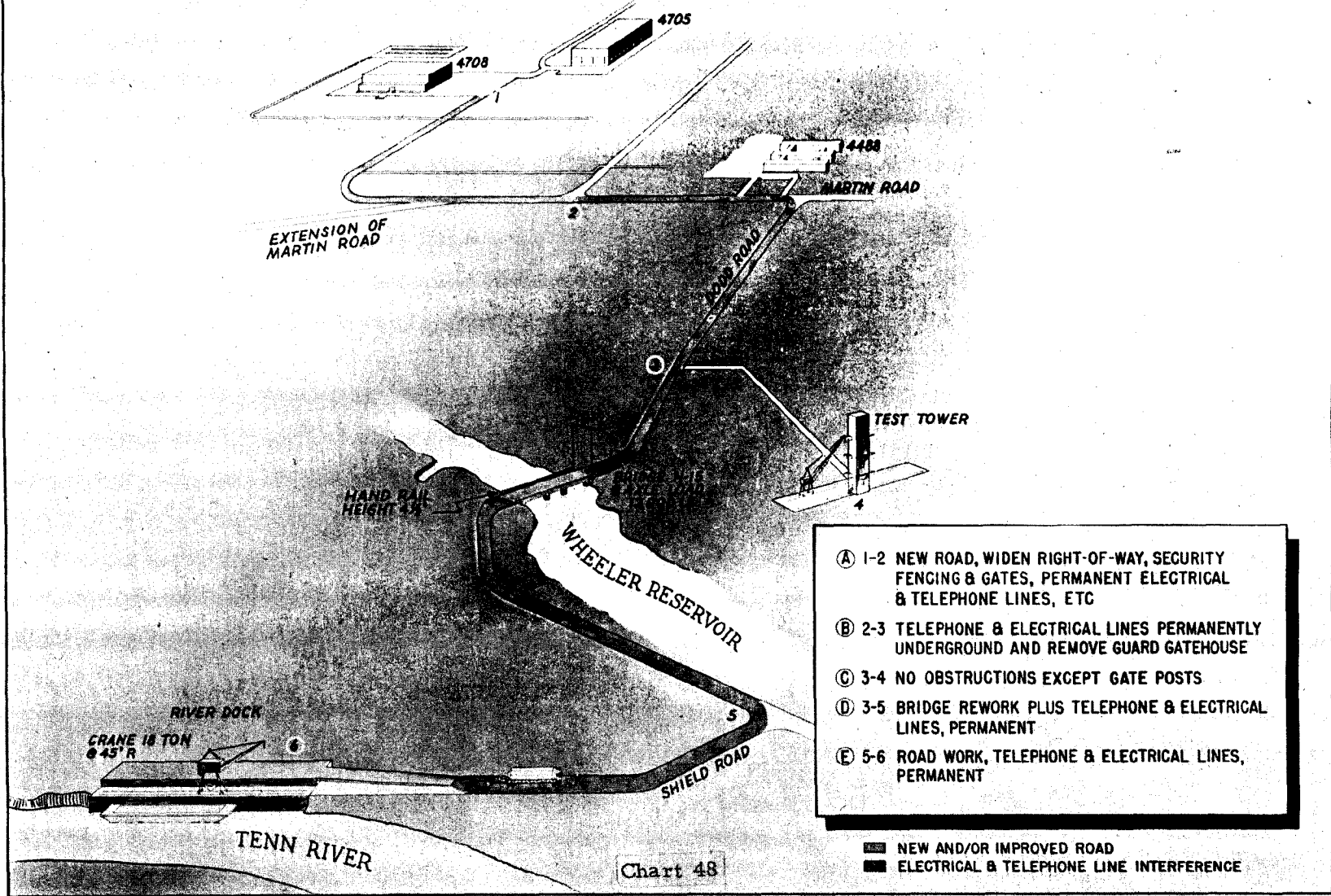

- (A) 1-2 NEW ROAD, WIDEN RIGHT-OF-WAY, SECURITY FENCING & GATES, PERMANENT ELECTRICAL & TELEPHONE LINES, ETC
- (B) 2-3 TELEPHONE & ELECTRICAL LINES PERMANENTLY UNDERGROUND AND REMOVE GUARD GATEHOUSE
- (C) 3-4 NO OBSTRUCTIONS EXCEPT GATE POSTS
- (D) 3-5 BRIDGE REWORK PLUS TELEPHONE & ELECTRICAL LINES, PERMANENT
- (E) 5-6 ROAD WORK, TELEPHONE & ELECTRICAL LINES, PERMANENT

 NEW AND/OR IMPROVED ROAD  
 ELECTRICAL & TELEPHONE LINE INTERFERENCE

Chart 48

*Recommended*  
**JUNO V (AMR) LAUNCHING SITE**

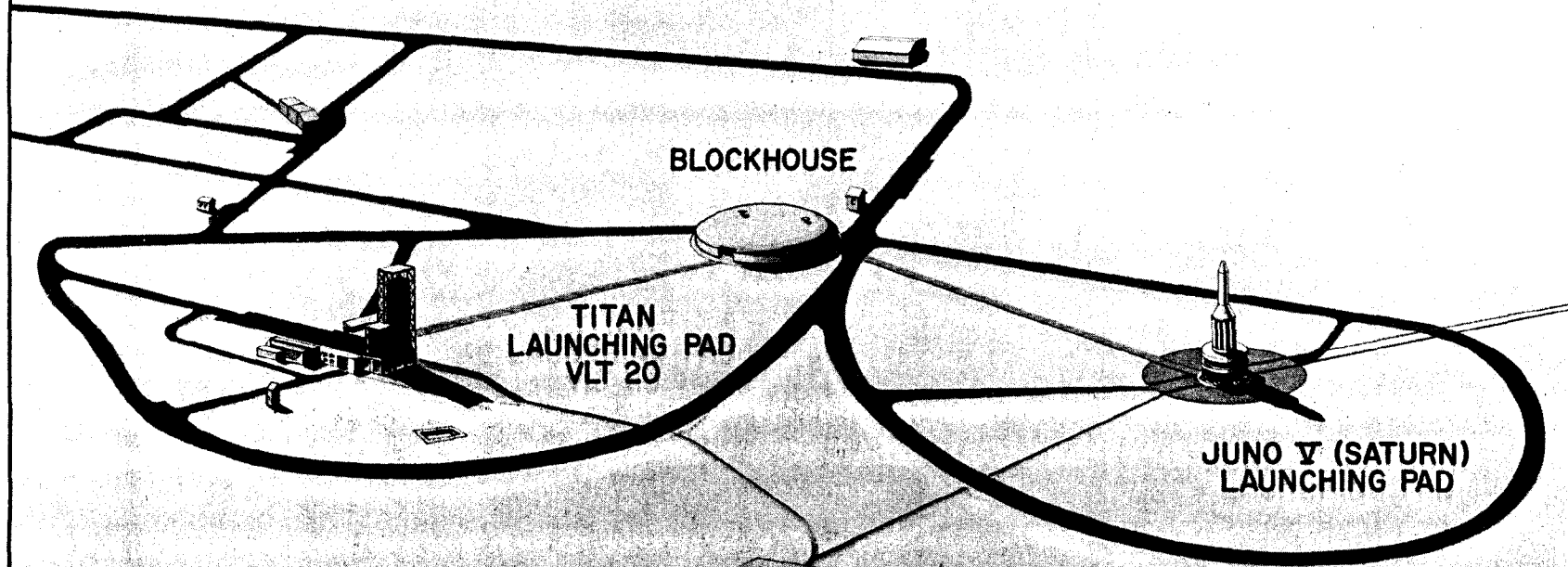

[REDACTED]

compressed air and a dumping pool for fuel in case of a mishap -- which was right out in the ocean.

Chart 50 shows what the launcher itself would look like. We made tentative studies, both with heavy steel and with concrete launching table, and found concrete was cheaper. So the launcher will be accessible by a staircase as is shown. The missile itself will be supported at eight points here, the so-called thrust frame. Four of these points will be rigid, and four will be retractable, because at these points the clamps reach over the hoods of the outer control engines, and, therefore, must be pulled out of the way for the missile to take off.

The next charts show how the unit will be brought into position on that launcher. As shown in Chart 51, we envision a crane similar to the one we have in Huntsville for the servicing of our big test stand.

The JUNO V will be brought on its transport into this position, and the crane will simply lift it up as is shown in Chart 52 and put it in position as indicated in Chart 53.

Incidentally, this is very much the same procedure we use on our JUPITERS and our crane operators tell us there will be no complications in doing this, even with such a large unit.

Of course, there may be conditions of very high winds when the erection may be a little difficult, but such days could probably be avoided.

You see the hold-down points very clearly in Chart 53. I would like to mention that the jet deflector, would be a dry deflector and good enough for about 3 to 5 seconds static firing. We have made provisions to roll this entire jet deflector out on rails, so that if a jet deflector is damaged, we can push another one in and repair this one.

MR. HYATT: What is the empty weight of the booster?

DR. VON BRAUN: 50,000 pounds.

We will attempt to recover the JUNO V boosters on the first two flight tests, and the scheme that we envision is the following: The booster will re-enter the atmosphere at anywhere between





ERECTION ASSEMBLY  
PHASE I

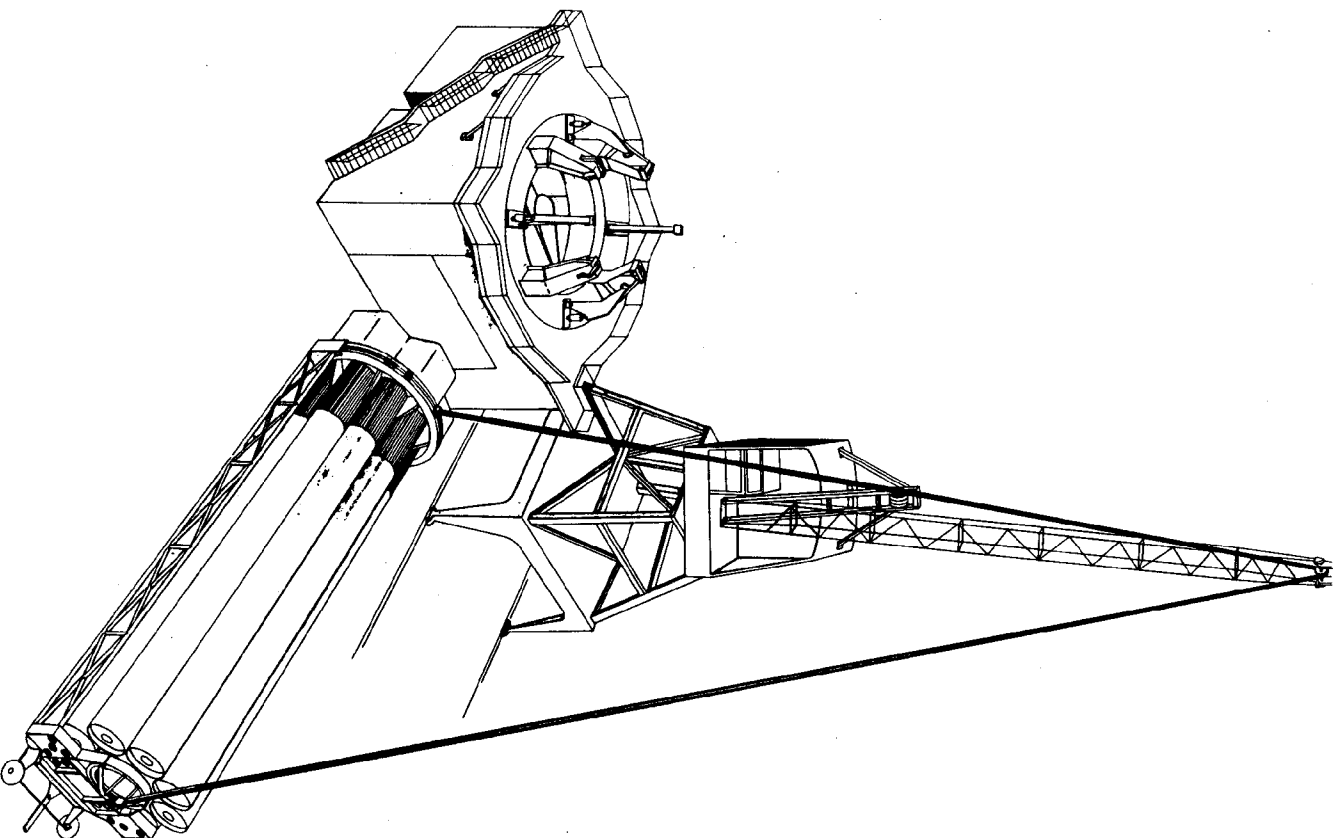
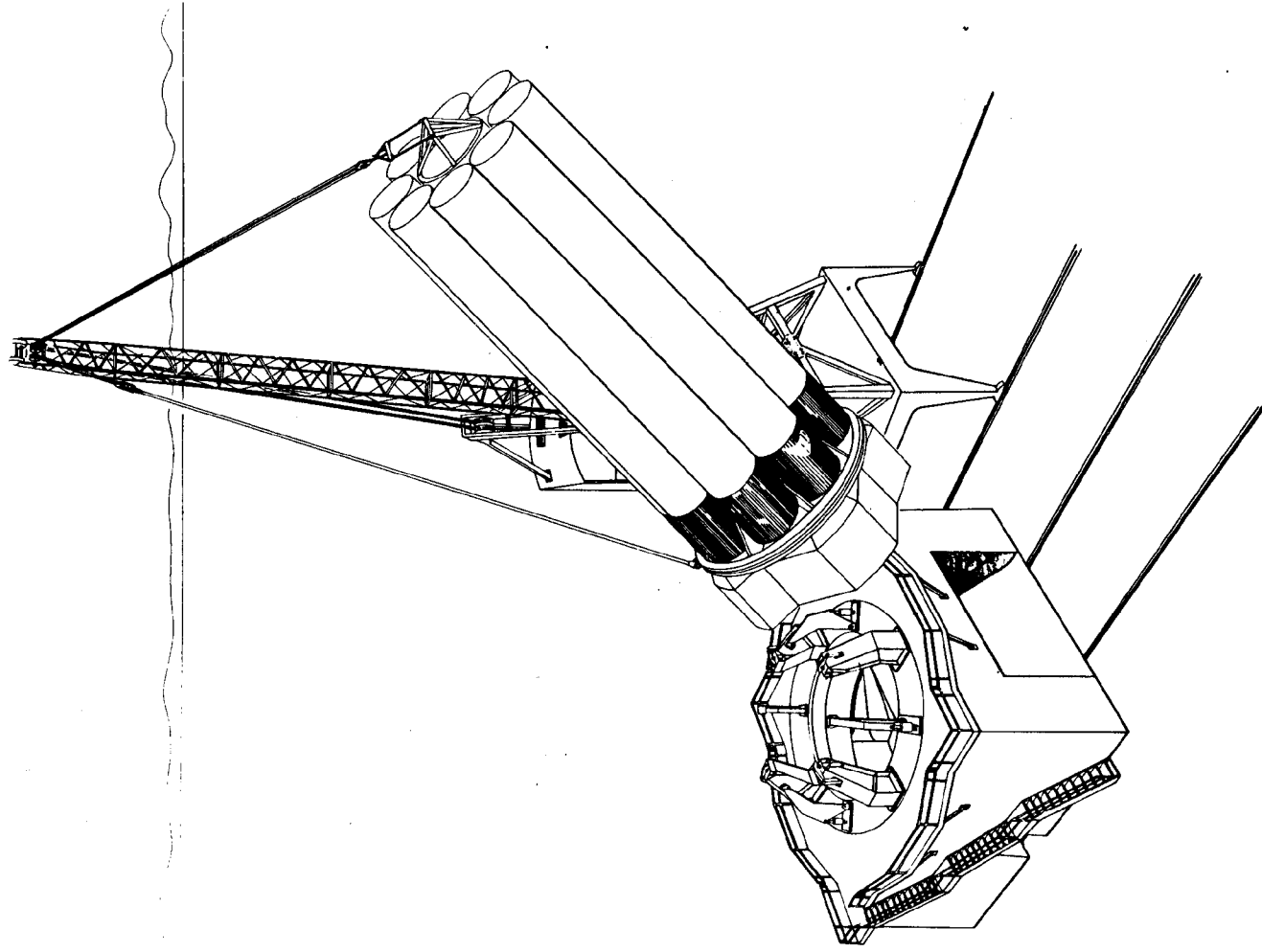

Chart 51

ERECTION ASSEMBLY  
PHASE II



ERECTION ASSEMBLY  
PHASE III

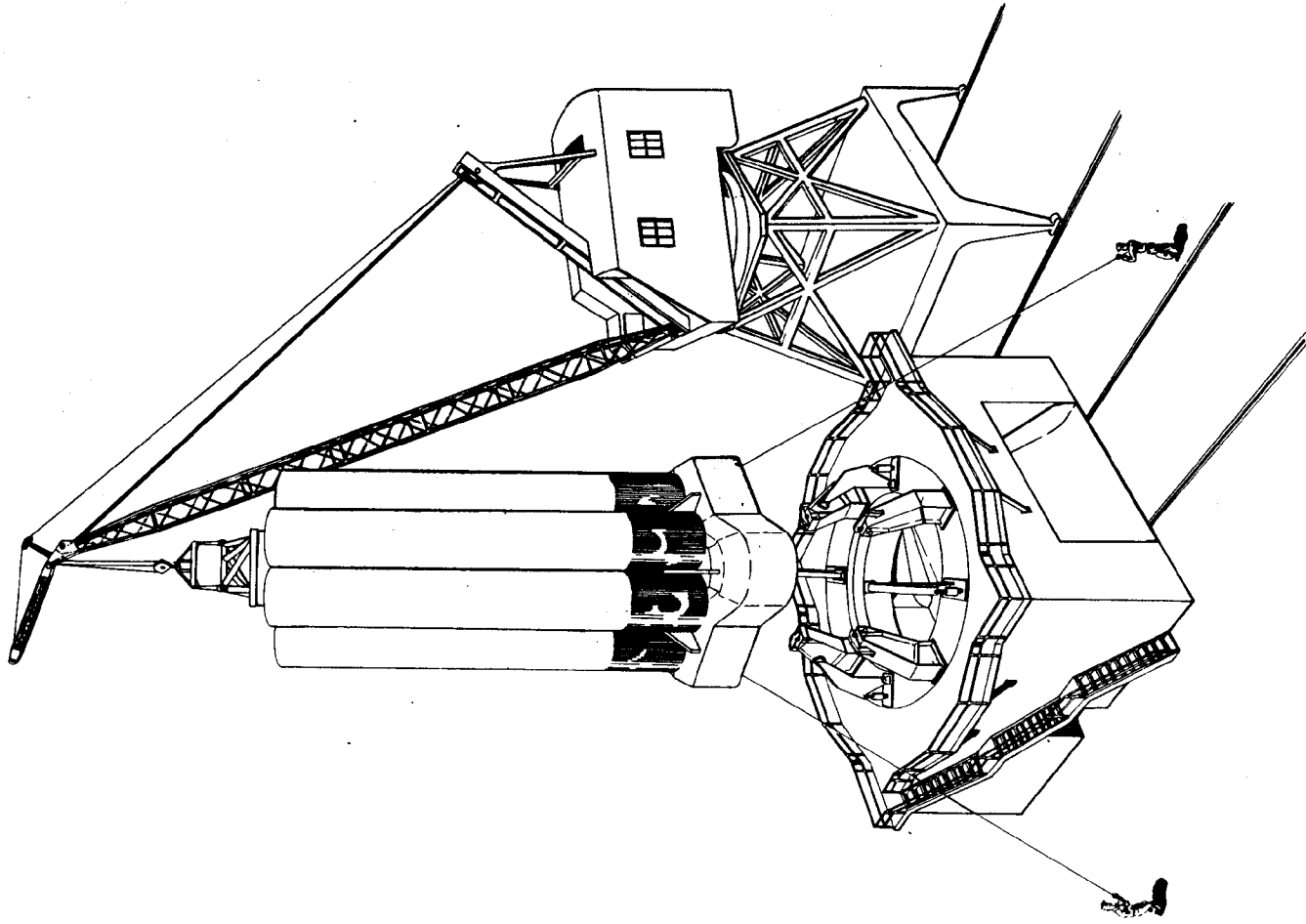

Chart 53

[REDACTED]

Mach 6 and 7, and it will probably tumble. During this tumbling descent into the atmosphere, it will lose speed and at about 10,000 feet, it will be down to a sub-sonic speed of about Mach 0.7.

At this point, a relatively small stabilizer parachute is to be deployed from the front end of the booster. This parachute will simply straighten out the unit and orient it so that it flies with the engines down.

After this has been accomplished, four or six large parachutes -- it will probably be four -- will be deployed, which will finally lower the unit down to the water at a rate of descent in the order of 30 to 45 feet per second.

At an altitude of approximately 100 feet, we propose to fire some solid rockets which will be mounted between the engines. These have about 2 seconds burning time. The total impulse of the solid rockets will be calculated to just nullify the residual kinetic energy so that the booster at an altitude of a few feet above the water will come to a standstill. The booster will then settle into the water as smoothly as a helicopter (Chart 54).

The tanks being empty, the booster will float. This is true even if several of the tanks were punctured.

The question of how to bring such a unit back to base has not been resolved completely. One way would be, of course, simply to tow it to Cape Canaveral. Another would be to have a heavy helicopter available to lift 50,000 pounds out of the water, and such a helicopter is not available yet.

Another would be to go out with a sea-going dock and under-swim the unit so to speak, and then lift it up with the unit on top of it.

The Navy tells us there are various ways of doing this, but nobody has said exactly how we should go about it. This procedure is now being studied.

Another possibility, of course, not entirely to be ruled out, is that as the booster floats in the water, you send some skin divers in there who simply take the outer tanks off and lift the inner units out by

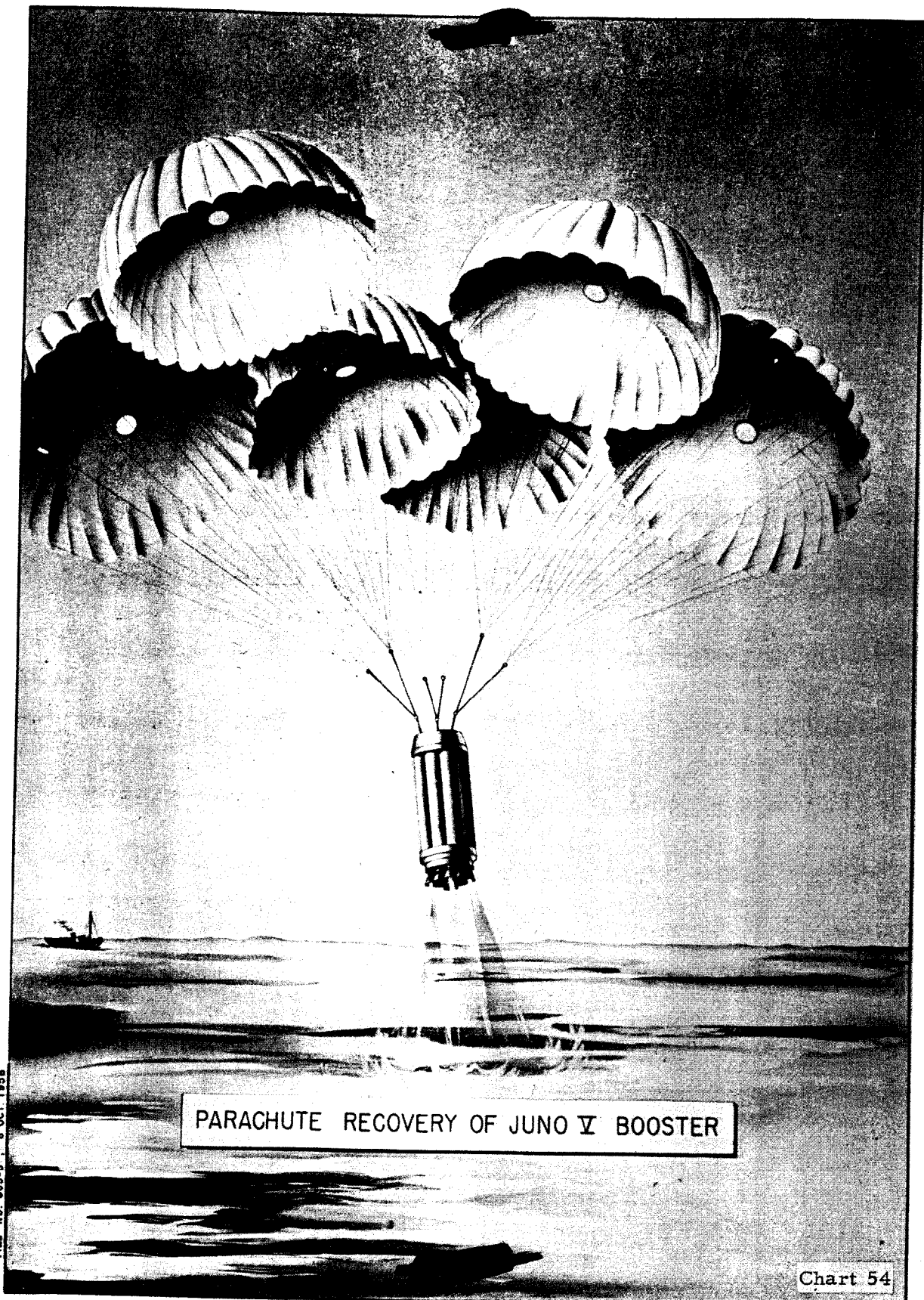

PARACHUTE RECOVERY OF JUNO V BOOSTER

FILE NO. 895-5 8 OCT. 1958

Chart 54

[REDACTED]

helicopter. In a smooth sea, there is no reason why this could not be done.

Chart 55 just debates, or discusses, the relative merit of booster recovery over the years.

Now, the figures that we have used for this calculation merely illustrate the point. If you feel it is too high or too low, just add your personal correction factors.

We have assumed here that, shall we say, 5 or 10 years from now, 100 vehicles would be fired per year, over a period of 5 years, in connection with some hypothetical orbital supply operations that we haven't spelled out in detail. We have further assumed that each such firing will cost \$10 million. We have also assumed that the reliability of the firing will be 96 percent; so that in order to have a total of 500 flights over a period of five years, we have to try 520 times. That is why the total price over a total of five years will be \$5.2 billion.

We have now assumed of the \$10 million per total flight, the booster itself, whose recovery we are debating here, will cost \$3 million, approximately one-third.

And, now, we can say this: if we don't recover at all, we just have to pay the full \$5.2 billion for the 500 vehicles, plus those that abort the mission, which makes a total of 520 flights. So we pay the full price indicated by the top line (Chart 55).

Let us consider the possibility that recovery is only 50 percent successful. That is, we recover only one out of two, and, at the same time, have to pay 50 percent, or \$1.5 million per recovered booster to rejuvenate it to the point where it can be reflown. In other words, there may be some damaged engines to be replaced, and so forth. In such a case, the savings would be exactly zero.

This is easy to see: with the 50 percent recovery and 50 percent rejuvenation cost, the saving would be zero.

However, if you are a little more optimistic and say that 80 percent of the vehicles are recovered and have a rejuvenation factor

# TOTAL PROJECT COST FOR PARACHUTE RECOVERY PLOTTED VS REJUVENATION FACTOR WITH BOOSTER RECOVERY PROBABILITY AS A PARAMETER

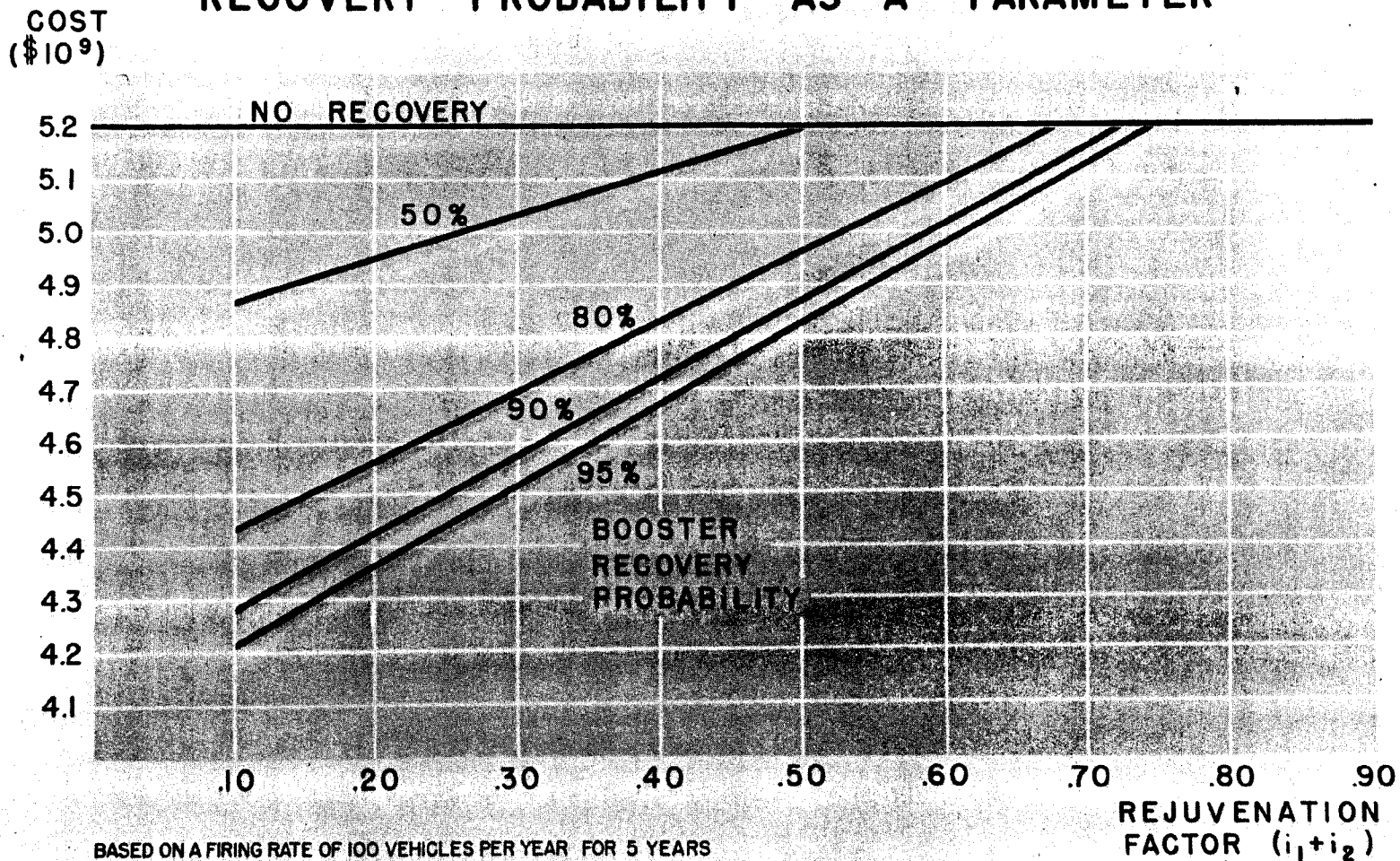

BASED ON A FIRING RATE OF 100 VEHICLES PER YEAR FOR 5 YEARS  
ASSUMPTIONS: \$10 MILL PER FIRING INITIAL COST  
\$ 3 MILL PER FIRST STAGE BOOSTER INITIAL COST

Chart 55

[REDACTED]

of only 20 to 25 percent, then your total bill will come down from \$5.2 billion to \$4.6 billion, which means over a period of four years, you have saved \$600 million.

The important thing is that the parachutes themselves for this kind of a landing are cheap. We pay only a few thousand dollars for a parachute package to salvage a 50,000-pound booster. And, so a lot of things can go wrong, and it will pay-off if only occasionally you save the hardware.

Not listed in this price analysis, of course, is the indirect advantage that will accrue to all of us if we have a capability of inspecting the boosters after flight, because every now and then something may be wrong. And, by having a capability of inspecting the hardware afterwards, you may be able to find a clue which would otherwise be missed.

Chart 56 and Chart 57 present the status quo of the JUNO V program.

The first four flight vehicles, plus a fifth one which is only for captive firing, have been actually approved and funded by ARPA. The present plan for the captive test (not shown on the chart) and for the four approved flights is as follows:

We are on schedule and are very optimistic that by Christmas 1959, or approximately one year from now, we will have the entire JUNO V booster ready for a captive firing with all eight engines burning for a period of 145 seconds.

We think we need a little over another half-year to build the first flight unit, and the first two units to fly will be flown in single-stage tests only. But we will, for stability and other reasons, have to add ballast in the nose to get the right acceleration characteristics; and for dynamics and control reasons, we would like to have the ballast in the form of the ultimate top stages so that the unit scheduled to fly in October 1960 will look like the final configuration. The second and third stages, though, will be just ballast. The units to fly in October 1960 will have a power rating of 150K per engine only, but all



# TYPICAL JUNO V SCHEDULE AND MISSION CHART (I)

103

VEH. NO.	TENTATIVE PROPOSED FIRING DATE	VEHICLE DESCRIPTION	FLIGHT MISSIONS
1 2	OCT 60 JAN 61	(A) 8x150K BOOSTER 650,000 LB USABLE PROPELLANT (B) 120-IN DUMMY STAGE II 120-IN DUMMY STAGE III (C) 120-IN INSTRUMENT COMPARTMENT (D) NOSE CONE	(1) PROPULSION TEST STAGE I (2) STRUCTURAL TEST (3) CONTROL SYSTEM TEST (4) BOOSTER RECOVERY SYSTEM TEST (5) LAUNCHING FACILITY CHECKOUT TEST
3 4	JUN 61 OCT 61	(A) 8x150K BOOSTER 750,000 LB USABLE PROPELLANT (B) 120-IN DUMMY STAGE II (FULL OR EMPTY) (C) 8x150K BOOSTER 650,000 LB USABLE PROPELLANT STAGE II (LOX/RP-1) (D) 120-IN INSTRUMENT COMPARTMENT (E) 120-IN PAYLOAD COMPARTMENT	(1) PROPULSION TEST STAGE I AND III (2) ORBITAL GUIDANCE TEST WITHOUT TRANSFER ELLIPSE (3) STRUCTURAL HIGH g TEST (4) SECONDARY SHORT LIFETIME ORBITAL PAYLOAD MISSION WITH ATTEMPT OF RECOVERY
5 6 7	DEC 61 FEB 62 APR 62	(A) 8x165K BOOSTER 650,000 LB USABLE PROPELLANT (B) 120-IN DUMMY STAGE II (FULL OR EMPTY) (C) 80K 120-IN DIAMETER 80,000 LB USABLE PROPELLANT STAGE III (LOX/RP-1) (D) 6K STORAGE KICK STAGE 6000 LB USABLE PROPELLANT (E) 120-IN INSTRUMENT COMPARTMENT (F) 120-IN PAYLOAD COMPARTMENT	(1) PROPULSION TEST STAGE I AND II AND KICK STAGE (2) GUIDANCE ACCURACY TEST FOR 96-min (306 N.M.) CIRCULAR ORBIT WITH TRANSFER ELLIPSE AND KICK MANEUVER (3) BOOSTER RECOVERY TEST (4) COMPLETE CONTROL SYSTEM TEST (5) RESEARCH INSTRUMENTATION FOR 306 N.M. ORBIT

Chart 56

# P R O P O S E D

## TYPICAL JUNO V SCHEDULE AND MISSION CHART (2)

VEH. NO.	TENTATIVE PROPOSED FIRING DATE	VEHICLE DESCRIPTION	FLIGHT MISSIONS
8 9 10	JUN 62 JUL 62 AUG 62	(A) 8x165 K BOOSTER 650,000 LB. USABLE PROPELLANT	(1) COMPLETE PROPULSION SYSTEM TEST
		(B) 200 K STAGE II (120-IN. DIAMETER) 160,000 LB. USABLE PROPELLANT (LOX / RP-1)	(2) GUIDANCE AND CONTROL TEST FOR SPACE MISSIONS
		(C) 80 K STAGE III 80,000 LB. USABLE PROPELLANT (LOX / RP-1)	(3) BOOSTER RECOVERY
		(D) 6 K STORABLE KICK STAGE 6,000 LB. USABLE PROPELLANT	(4) SECONDARY SPACE PROBE MISSIONS SUCH AS: LUNAR SATELLITE LUNAR HARD LANDING INTERPLANETARY PROBE
		(E) 120-IN. INSTRUMENT COMPARTMENT	(5) CHECKOUT OF EQUATORIAL LAUNCHING SITE PAYLOAD=20,000 lb
		(F) 120-IN. PAYLOAD COMPARTMENT	
11 12 13 13A	SEP 62 OCT 62 NOV 62 DEC 62	(A) 8x165 K (188 K) BOOSTER 650,000 LB. USABLE PROPELLANT	(1) PROPULSION SYSTEM TEST
		(B) 200 K STAGE II 160,000 LB. USABLE PROPELLANT (LOX / RP-1)	(2) GUIDANCE AND CONTROL TEST FOR 24-HOUR ORBIT
		(C) 30 K STAGE III (120 IN.) 30,000 LB. USABLE PROPELLANT (H <sub>2</sub> /O <sub>2</sub> )	(3) BOOSTER RECOVERY
		(D) 6 K STORABLE KICK STAGE	(4) PAYLOAD CONTROL SYSTEM TEST
		(E) 120-IN. INSTRUMENT COMPARTMENT	(5) COMMUNICATION PAYLOAD COMPONENT TEST IN 24-HR. ORBIT
		(F) 120-IN. PAYLOAD COMPARTMENT	PAYLOAD = 5,000 lb
14 15 16	JAN 63 FEB 63 MAR 63	(A) 8x188 K BOOSTER 650,000 LB. USABLE PROPELLANT	(1) PROPULSION SYSTEM
		(B) 200 K STAGE II 160,000 LB. USABLE PROPELLANT	(2) GUIDANCE AND CONTROL TEST FOR RENDEZVOUS MANEUVER IN 306 N.M. ORBIT
		(C) 80 K STAGE III 80,000 LB. USABLE PROPELLANT	(3) FLIGHT MISSION TEST FOR ORBITAL RENDEZVOUS AND RETURN (BIOLOGICAL SPECIMEN)
		(D) 6 K KICK STAGE 6,000 LB. USABLE PROPELLANT	
		(E) INSTRUMENT COMPARTMENT	

ARPA & NASA?

ARPA

NASA



eight engines will be burning. We have reduced the potential propellant load from 750,000 pounds to 650,000 pounds in order to get into the right speed ranges for recovery.

This is the same speed range for the booster which we ultimately suggest for the three-stage operation of this vehicle, where booster recovery is very desirable.

The dummies for the second and third stages will probably be crude battleship cylinders topped by some kind of nose cone. These battleship cylinders will be filled with water to ease their handling and serviceability on the test stand.

We shouldn't forget that these units together weigh approximately 250,000 pounds, so it would be a very awkward thing to use a concrete ballast and then have to lift these dummy stages from the missile for some reason. So we will fill the dummy stages with water.

There would be an instrument compartment, probably rather rudimentary, just to make the flight possible. And the flight missions will be the ones shown here, which are basic propulsion, structural test, control system, and, of course, booster recovery and launching facility checkout.

June 1961, approximately a year and a half after the first static firing, we hope to be able to fire a two-stage configuration. It will be the same booster; but, in this case, in order to get a useful orbital payload, we use a propellant load up to 750,000 pounds in the first stage to get much more speed out of it, which means we may not be able to recover the booster.

There will be a dummy second stage (in order to reduce the total number of geometries, layouts, to only one). The question of whether it will be filled or empty has not been decided yet.

And then -- and this is the important step -- we might put an 80K Rocketdyne sustainer engine or a TITAN II engine in a 120-inch airframe on top of it, and this will be the third stage.

This will give us an orbital capability which is not very impressive. It depends on whether we fire the dummy stage filled.

[REDACTED]

This would give us the exact acceleration characteristics for the first stage flight, but will cost us payload. If we fly it empty, we will be shooting after payload, and the acceleration will be changed somewhat. Depending on how we do this, the payload capability would be only between 3,000 and 5,000 pounds, which is not much more than what the ATLAS can do. But it will be available in the summer of 1961. Again, the purposes or missions of the flights are shown here to the right.

Beginning with December 1961, we are dealing strictly with what is proposed and not approved yet. Remember, what we have discussed previously has been approved by ARPA; it has been budgeted by ARPA; and the facility money that goes with it has also been assigned to us.

Now, ARPA plans to use the JUNO V for the ultimate communication satellite of 5,000 pounds or more in a 24-hour orbit. The entire development is oriented towards the earliest possible accomplishment of this one mission.

Of course, there are several improvements over these early configurations that are necessary before this can be done, because the 24-hour orbit is the particularly nasty one which requires speeds higher than escape velocity.

The next three missiles we are proposing will, first, uprate these engines from 150 to 165K - and North American already has this on schedule, and go back to 650,000 pounds propellant in the first stage. Now we will, for the first time, add the JPL 6K kick stage to the units. We need the kick stage for the final injection of the top stage into an exact 24-hour circular orbit.

The purpose of this test would be to try methods to guide a unit into an exactly circular orbit, in this case still at lower altitudes, which we feel is quite a tricky requirement. So far, we have been happy if our satellites went high enough and fast enough and stayed in orbit for a couple of weeks. But with the communications satellite, we have to be careful not to miss the 24-hour orbit by as little as a minute or half a minute, because it will fall out of step. And there would be additional correction devices necessary.

[REDACTED]

All this will be done with Vehicles 5, 6, and 7. This still can't carry the full payload to the 24-hour orbit.

To our present thinking, the next three flights 8, 9 and 10 will then feature the 200K second stage. So far there has been no second stage; and, remember, this might not be available until 1962, and it is a must for the communication satellite. That's why we have these three additional flights with the 200K second stage and the 80K and the 6K stages on top of it.

We think we need these flights as a stepping stone toward the ultimate communication satellite.

In September 1962, we hope to find that the eight engines are uprated to 188K. We believe as we have indicated that a second stage will already be available; and we hope that the third stage Pratt and Whitney will be available, since this is the important improvement at this point. These three stages with a kick stage for final kick in the apogee will give us the 24-hour orbit and the communications payload we are aiming for.

Now, what comes thereafter will be to convert this experiment - and we hope it will be successful - into a useful communication system, and this may require a few more flights.

Now let me go back to three vehicles numbered 8, 9, and 10.

We believe that, although to conduct these flights is a necessary intermediate step to get the communication satellite into orbit in the latter part of 1962, it is entirely possible to give these three flights some kind of space missions.

For example, we could, without penalizing the basic development program for the vehicle in any way, combine this with such things as a guidance and control test for space missions, or secondary space probe missions, such as lunar satellite, lunar hard landing, or interplanetary probe. Remember the basic vehicle with all its stages is essentially the same and does not serve the communication satellite directly, but only indirectly. Why not use it as a space vehicle? It would really offer NASA -- and this is now really a sales pitch here --

[REDACTED]

a very substantial capability with heavy payloads far exceeding anything you can get out of the SUPER-ATLAS as early as the latter part of 1962.

How, to work this out in detail, will probably require some discussions between NASA and ARPA; but from our point of view, it seems entirely feasible to do this.

This actually ends my presentation on the JUNO V, but I would like to add a few more minutes to my presentation to discuss a problem of very general concern to all of these programs, and it has some bearing on JUNO V as you will see in a moment.

What we have analyzed here on a number of charts -- I won't go into too much detail -- is what will it take to get people to the surface of the moon and back.

Now, there are various ways of doing it. One way, (Chart 58) of course, is that you fly from the surface of the earth directly to the surface of the moon and fly back directly from the surface of the moon to the surface of the earth. This will require four stages for escape from the earth at first; then it will require another stage for the landing on the moon; another stage for the escape from the moon; and finally another stage somehow to implement your landing on the earth assuming a hypercircular re-entry into the atmosphere.

Our investigations in the area of a manned flight to the moon and return have brought us to a very important conclusion. Assume first that the state of the art in 1960-1962 has advanced to the point that high energy upper stages are actually available. Then limit your payload to 1,000-pounds - that is to two people plus whatever personal belongings they need; and encase these personnel in a capsule having a total weight conservatively estimated at 13,600 pounds including the 1,000 pounds allotted the personnel. Now what would it take to get this 13,600 pounds to the moon and back?

You would need a seven-stage vehicle which weighed no less than 13.5 million pounds. You couldn't do this even with a 6 million pound power plant that used hydrogen and oxygen in the upper stages.

# TRAJECTORY SCHEME I

114

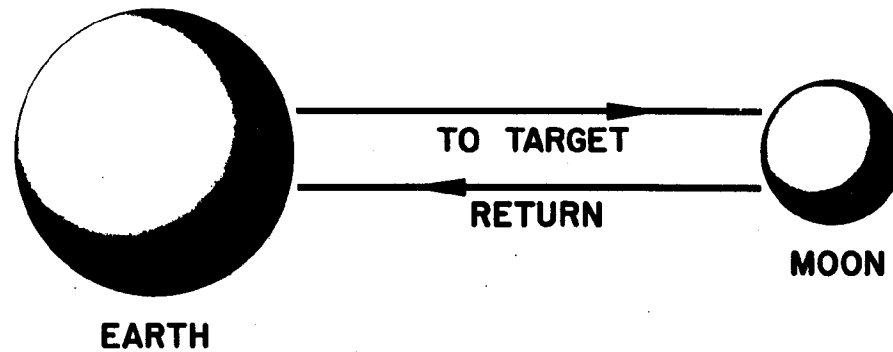

<u>MANEUVER</u>	<u>STAGES</u>	<u>VEHICLE</u>	$W_0$	$W_{1+2}$ $13.6 \cdot 10^3$ LB.
1. EARTH ESCAPE	4	A	A: $13.5 \cdot 10^6$ LB., 7 STAGES	$W_{11+12}$ $1 \cdot 10^3$ LB.
2. LUNAR LANDING				$M_{11+12,T}$ $13.5 \cdot 10^3$
3. LUNAR ESCAPE				
4. EARTH LANDING				

ADVANT.: UNCOMPLICATED BASIC SCHEME.

DISADV.: EXTREMELY LARGE VEHICLE, LOW RELIABILITY, LATE IN TIME, UNFLEXIBLE, HIGH SPEED RE-ENTRY

[REDACTED]

I think there has been a lot of loose talk in this area as to whether this can be done so easily. It looks to us as if it can not be easily done, and we believe that the assumptions on which we have based our conclusions have been slightly on the optimistic side.

Let me put this chart (Chart 59) up here just to show you in comparison with other schemes what this would take.

This is a kind of vehicle -- we have not bothered streamlining it here -- which gives you an idea of what it would take to accomplish this moon trip compared to other schemes using other fuel techniques.

The second possibility is this: you use fifteen much smaller vehicles. Now, it just so happens that this vehicle has the size and weight of the JUNO V vehicle. With fifteen JUNO V three-stagers, you could carry sufficient payload into orbit to build up one vehicle of 447,000 pounds which would depart from a circular orbit (Chart 60).

Now, this would be a loosely jointed array of tanks, not streamlined at all. Part of this actually could consist of the top stages of JUNO V proper that you would strap together, because this vehicle departs from an orbit and what finally returns to the earth is only the nose cone anyway. So the rest can burn up or be abandoned in flight.

This vehicle (Type C) as it goes along, throws away tanks and motors, four sets of them: one after orbital escape has been completed; one after the lunar landing has been completed -- in other words, leave some junk behind on the moon; one after lunar escape; and this one, finally, after the correction for re-entry into the earth's atmosphere.

With this vehicle, you can accomplish the moon trip with much, much smaller units. Instead of having one such big unit which has to be developed first, you do it with fifteen flights of this JUNO V vehicle as an orbital supply operation. And, of course, you need a deep-space vehicle. This you assemble in an orbit, and, just for your information, it would be approximately this type (Type C, Chart 59). This is simply based on the tank volumes that it takes for the four stages.



# VEHICLE FAMILY FOR LUNAR EXPEDITION

116

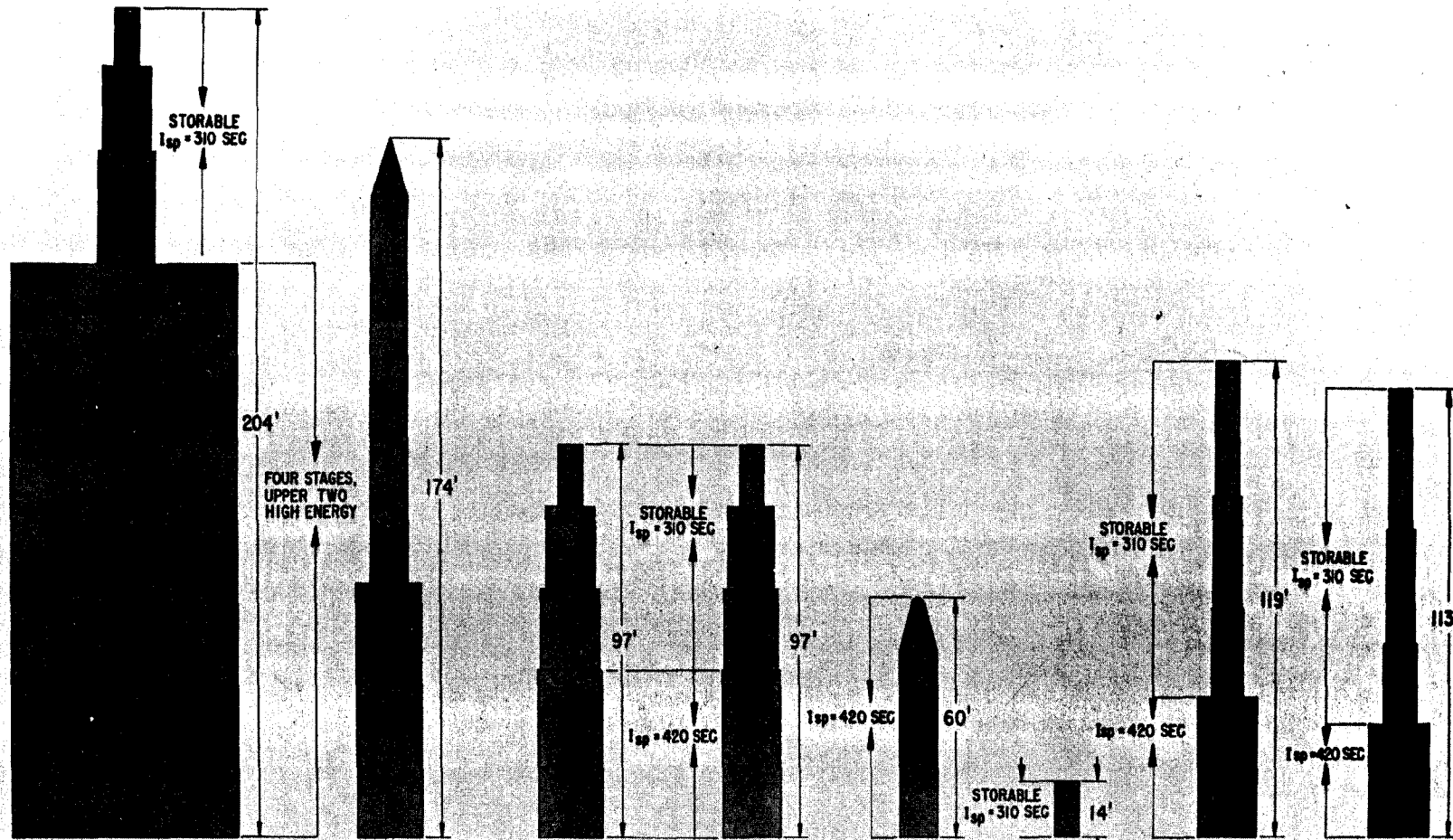

**A**  
EARTH-GROUND  
LAUNCH-VEHICLE

**B**  
JUNO V  
TYPE VEHICLE

**C**  
DEEP-SPACE-VEHICLE

**E**  
PICK-UP VEHICLE  
JUPITER TYPE

**F**  
EARTH RETURN  
VEHICLE

**G**  
DEEP-SPACE VEHICLE  
USING ORBITAL TECHNIQUE  
ON THE LUNAR SIDE

**H**  
DEEP-SPACE VEHICLE  
USING ORBITAL TECHNIQUE  
ON THE LUNAR SIDE

## TRAJECTORY SCHEME 2

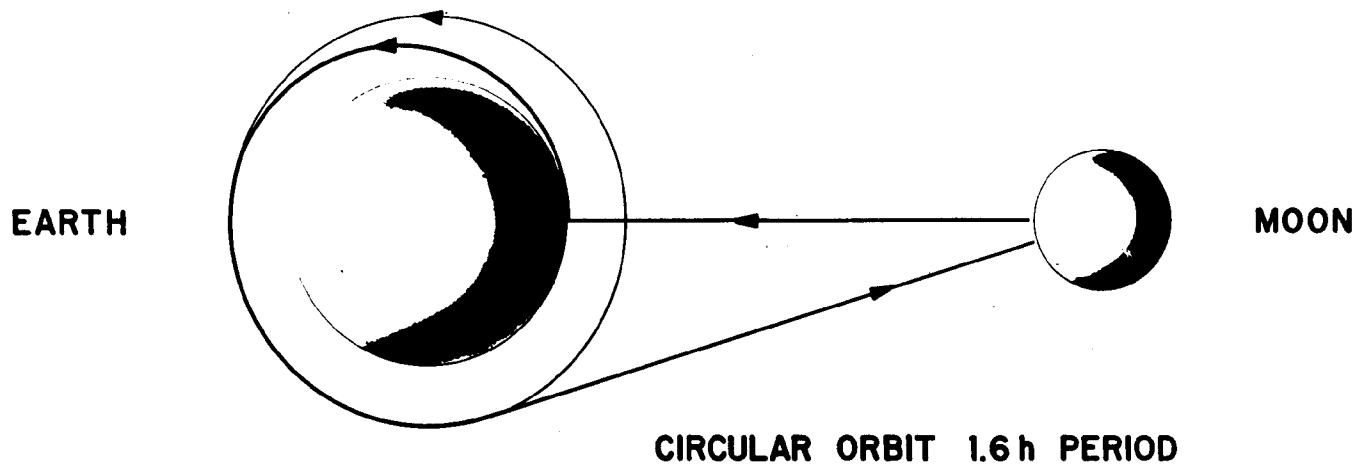

<u>MANEUVER</u>	<u>STAGES</u>	<u>VEHICLE</u>	$W_0$	$W_{1+2}$ 13.6 · 10 <sup>3</sup> LB
1. EARTH TO ORBIT	<u>3</u>	B	15x 1.07 · 10 <sup>6</sup> LB, 3 STAGES EA.	$W_{11+12}$ 1 · 10 <sup>3</sup> LB
2. ORBITAL ESCAPE	1			$M_{11+12,T}$ 17.1 · 10 <sup>3</sup>
3. LUNAR LANDING	1			
4. LUNAR ESCAPE	1	C	447.5 · 10 <sup>3</sup> LB, 4 STAGES	
5. EARTH LANDING	1			

ADVANT: SMALLER VEHICLES ONLY  
 FAIRLY SIMPLE BASIC SCHEME

DISADV: HIGH-SPEED RE-ENTRY

[REDACTED]

So from fifteen such flights, we build together a unit of this size, which can do the whole trick, in lieu of having one like the single earth-based one.

Remember that this is also assumed to be a direct so-called hypercircular re-entry. In other words, you just kick the thing away from the moon; and, of course, the moment it is freed from the moon, and starts falling down to the earth, it is building up to practically escape velocity as it falls. And, with the last power plant, all you have to do is space the thing properly to get into the proper approach hyperbola with relation to the earth; and then by aerodynamic means, not only to slow down from circular speed like your NASA capsule, but from hyperbolic speed. This is something that pays off to develop, because if you don't do that, you have to provide fuel to reduce the hyperbolic speed to circular speed before you begin your re-entry, and this fuel has to be carried all the way to the moon and back. It costs you very, very heavily in terms of initial weight.

Now, we do not know whether such hyperbolic re-entry will be possible; and what we show here is, therefore, based on circular re-entry only because we are assuming that you just can't do better than circular re-entry, and, somehow you have to provide for return.

This is a rather complicated way of doing the thing, but the idea is essentially the following: You will take eighteen of these JUNO V carriers to carry a payload into the orbit. Now, you build together in the orbit the vehicle called "D", which weighs 450,000 pounds at take-off. It is a four-stage vehicle and has the job of escaping from the orbit, landing on the moon, escaping from the moon; and now transferring the thing as it comes back - not into a circular orbit but into a long stretched elliptical orbit.

This is, of course, cheaper, far cheaper, than to go from hyperbolic approach speed into a circular orbit. So the lunar vehicle goes into the elliptical orbit (Chart 61).

# TRAJECTORY SCHEME 3

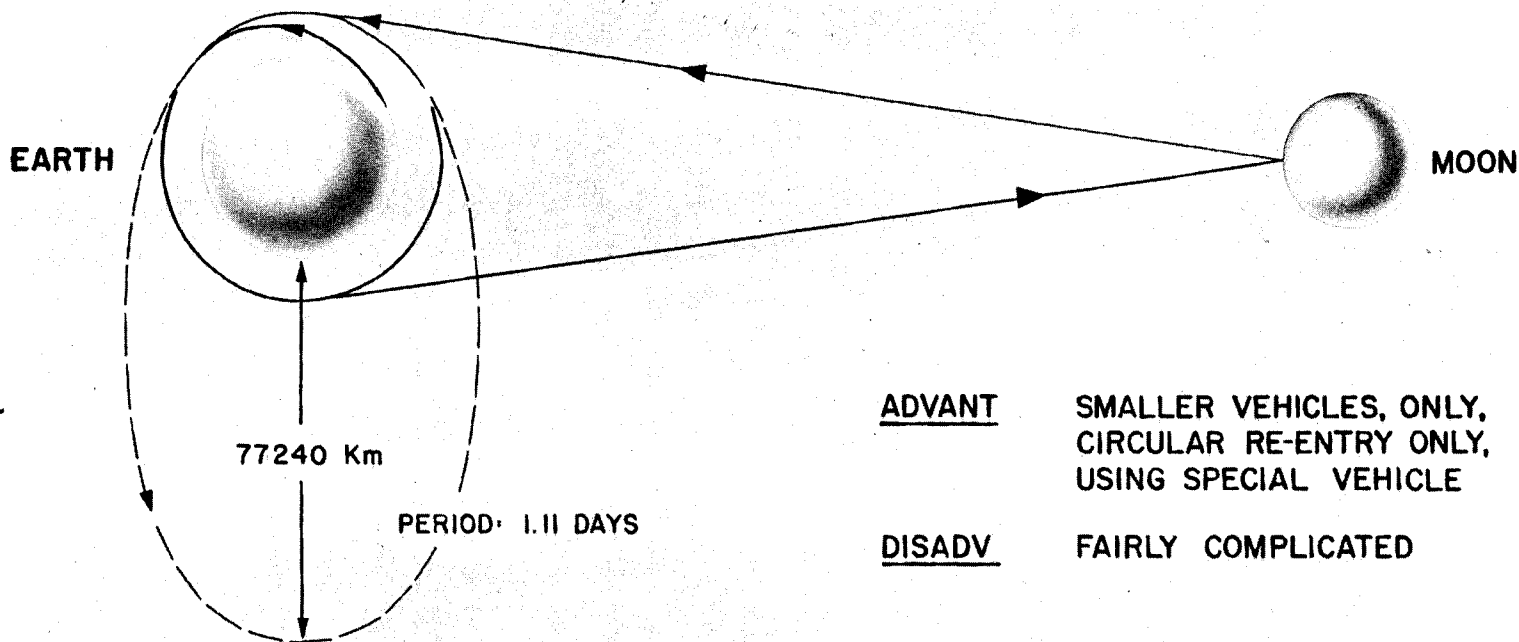

ADVANT SMALLER VEHICLES, ONLY,  
CIRCULAR RE-ENTRY ONLY,  
USING SPECIAL VEHICLE

DISADV FAIRLY COMPLICATED

<u>MANEUVER</u>	<u>STAGES</u>	<u>VEHICLE</u>	<u>W<sub>0</sub></u>		
1. EARTH TO ORBIT	3	B	15 x 1.07 · 10 <sup>6</sup> lb, 3 STAGES	W <sub>1+2</sub>	11 · 10 <sup>3</sup> lb
2. ORBITAL ESCAPE	1			W <sub>11+12</sub>	1 · 10 <sup>3</sup> lb
3. LUNAR LANDING	1	D	415 · 10 <sup>3</sup> lb, 4 STAGE	M <sub>11+12</sub>	19.3 · 10 <sup>3</sup>
4. LUNAR ESCAPE	1				
5. TRANSFER TO ELLIPTICAL ORBIT	1				
6. EARTH TO ORBIT	3	B	3 x 1.07 · 10 <sup>6</sup> lb, 3 STAGES		
7. ORBIT TO ELLIPTICAL ORBIT	1	E	70 · 10 <sup>3</sup> lb, 1 STAGE		
8. ELLIPTICAL ORBIT TO ORBIT					
9. EARTH LANDING	1	F	10 · 10 <sup>3</sup> lb, 1 STAGE		



And now a third type vehicle would be required, departing from the orbit, and assembled with cargo carried up with part of these JUNO V's here, to get the stranded moon crew out of this elliptical orbit. This requires another vehicle of 70,000 pound thrust; and which slows itself to circular speed. The earth's landing itself can then be done with the vehicle solely designed for earth return, which could be something like that capsule for the JUNO V that I explained previously to get the 16 men into orbit and back. In other words, it would be a nose cone capable of re-entering.

So, in this fashion, you can have your cake and eat it, too. You go to the moon from an orbit around the earth. Then rather than returning by means of the circular orbit, you return by means of the elliptical orbit. And you need a way of getting the crew from the elliptical orbit, so you use a special retriever vehicle, which saves you the trouble of carrying the fuel all the way to the moon.

A fourth scheme (Chart 62) is to go from the orbit around the earth to the moon, but, instead of landing on the moon, go to a satellite around the moon, and leave some of the fuel in that satellite orbit. It is obvious that this leaves you with a potential energy of lifting all that fuel on the return flight out of the moon gravitation field again.

You can leave the moon with a flying start, so to speak; and this actually results in some substantial savings.

From the point of view of total mass -- this factor here, "M" represents the number by which you multiply one pound of useful payload in order to get the total weight of the effort in terms of accumulated take-off weights of all supply rockets from the ground. This factor would be lowest in this case. But you see, it is a pretty complicated scheme. You first go with twelve JUNO V's into orbit, carry enough material up there to assemble a 337K pound five-stager; and this thing goes into orbit; only part of it lands on the moon, and this part that lands on the moon refuels again from the fuel left behind in the lunar orbit. And finally, you need a high-speed re-entry again in order to make it fully attractive.

# TRAJECTORY SCHEME 4

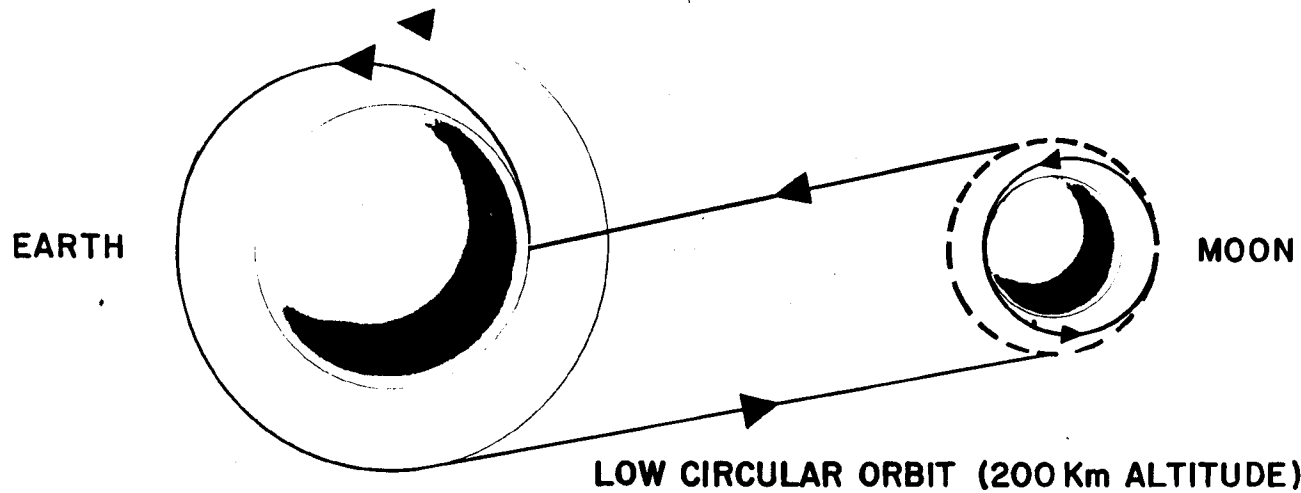

<u>MANEUVER</u>	<u>STAGES</u>	<u>VEHICLE</u>	$W_0$	$W_{1+2}$ $13.6 \cdot 10^3$ LB
1. EARTH TO ORBIT	<u>3</u>	B	$12 \times 1.07 \cdot 10^6$ LB, 3 STAGES EA.	$W_{11+12}$ $1 \cdot 10^3$ LB
2. ORBITAL ESCAPE	1	G	$337.7 \cdot 10^3$ LB, 5 STAGES	$M_{11+12,T}$ $12.8 \cdot 10^3$
3. LUNAR ORBIT	1			
4. LUNAR LANDING	1			
5. MOON TO LUNAR ORBIT	1 & REFUELING			
6. LUNAR ORBITAL ESCAPE				
7. EARTH LANDING	1			

ADVANT. SMALLER VEHICLE ONLY  
REDUCED GROWTH FACTOR

DISADV. HIGH-SPEED RE-ENTRY  
FAIRLY COMPLICATED

[REDACTED]

Here is, finally (Chart 63), a fifth scheme, which combines the lunar orbiting with the elliptical orbit, and that looks quite attractive too, but is probably the most complicated of all of them.

I wanted to bring this matter to your attention because we feel very strongly at ABMA that these kinds of things should be investigated carefully. This is merely, shall we say, an illustration of a problem with which we are going to be faced rather than a proposal on how to do it.

And specifically we would like to have, if this can be discussed here and if it is proper for me to discuss it at this moment, some kind of an assignment from NASA to continue studies of this nature.

DR. SILVERSTEIN: I think it probably would be better if you held that until later. I think it probably isn't the best place to do it and not in line with our --

DR. VON BRAUN: May I do it, then, without offering our services for it?

DR. SILVERSTEIN: All right.

DR. VON BRAUN: I will just give the problems while your memory is fresh.

The development of the JUNO V type carriers and permanent, large, manned space stations will give the capability of a manned lunar landing without necessitating large vehicles. This is what I am trying to point out. So there is no need for a larger booster from this point of view.

Now, we believe rendezvous maneuvers and the guidance problems in connection with rendezvous maneuvers should be very carefully studied. By rendezvous maneuvers, I mean how to meet an existing rocket in an orbit. We believe that equipments, such as space suits should be very carefully investigated so we know how to establish contact with the other man; that such things as how to run a fuel line if you want to refuel, how to take a tank out of one rocket and attach it to another - in short, that the whole area of performing work in an orbit should be explored.

# TRAJECTORY SCHEME 5

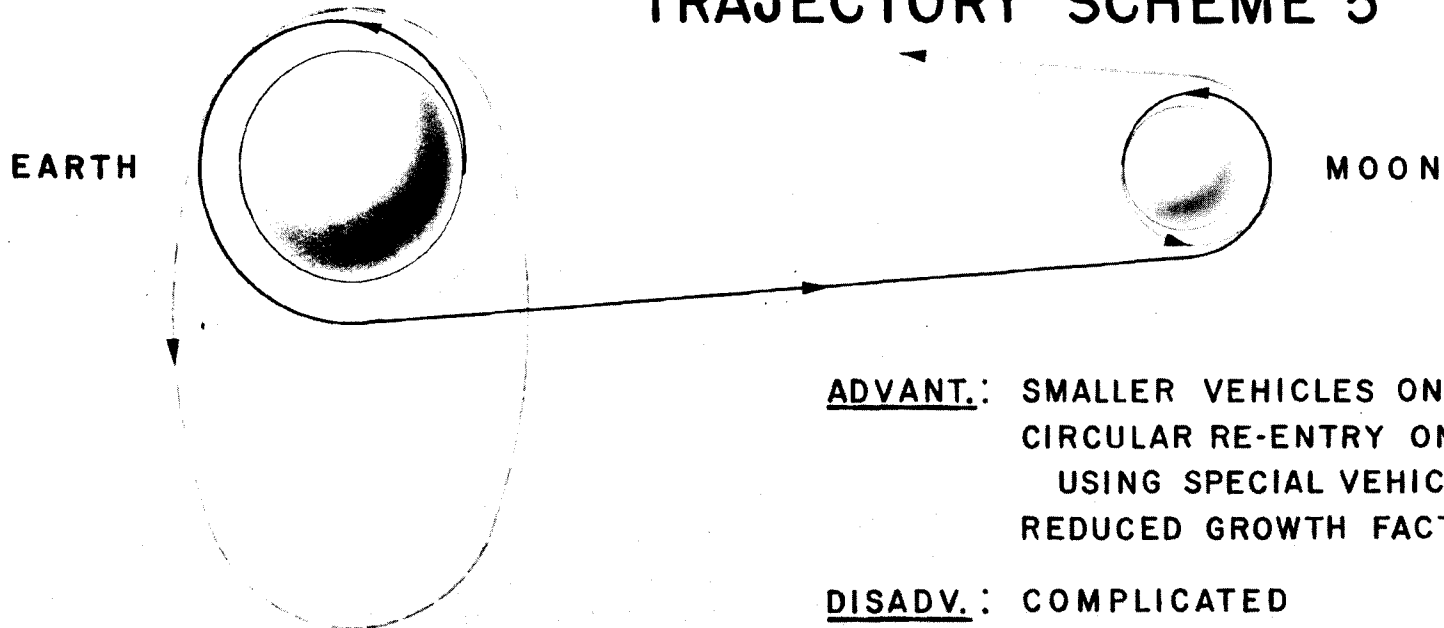

ADVANT.: SMALLER VEHICLES ONLY  
 CIRCULAR RE-ENTRY ONLY  
 USING SPECIAL VEHICLES  
 REDUCED GROWTH FACTOR

DISADV.: COMPLICATED

<u>MANEUVER</u>	<u>STAGES</u>	<u>VEHICLE</u>	$W_0$	$W_{1+2}$ $11 \cdot 10^3$ LB.
1. EARTH TO ORBIT	<u>3</u>	B	$11 \times 1.07 \cdot 10^6$ LB., 3 STAGES EA.	$W_{11+12}$ $1 \cdot 10^3$ LB.
2. ORBITAL ESCAPE	1			$M_{11+12,T}$ $15.0 \cdot 10^3$
3. LUNAR ORBIT	1			
4. LUNAR LANDING	1			
5. MOON TO LUNAR ORBIT	1+	H	$291.8 \cdot 10^3$ LB., 5 STAGES	
6. LUNAR ORBITAL ESCAPE	REFUELLING			
7. TRANSFER TO ELLIPTIC ORBIT	<u>1</u>			
8. EARTH TO ORBIT	<u>3</u>	B	$3 \times 1.07 \cdot 10^6$ LB., 3 STAGES	
9. ORBIT TO ELLIPTIC ORBIT	<u>1</u>	E	$70 \cdot 10^3$ LB., 1 STAGE	
10. ELLIPTIC ORBIT TO ORBIT	<u>1</u>	F	$10 \cdot 10^3$ LB., 1 STAGE	
11. EARTH LANDING	1	F	$10 \cdot 10^3$ LB., 1 STAGE	



[REDACTED]

Then, by properly planning the vehicle for the various missions, we believe the restarts can be avoided. And we think in all optimum considerations of lunar and planetary missions, we should always keep in mind that restart is a nasty thing, no matter how you look at it.

We think it is highly advantageous, particularly if you have long transfers, free coasting transfer times, that stages that you fire up later should not have been touched to prevent corrosion or leakage problems. Therefore, what you really start up is a sealed unit which you know was in good shape when the mission began.

Next, we believe that the problem of hypercircular re-entry should be very carefully studied. So far, we are dealing only with re-entry from circular orbits and, of course, we haven't solved that problem yet. But I think that for missions, like returns from the moon or circling the moon, etc., the question of how to retard a rocket that comes back at hypersonic speed or near parabolic speed is of the utmost importance. This is not only a heating problem, but a guidance problem, as well as for a vehicle coming back from the moon and re-entering using the braking ellipse technique. The earth keeps rotating underneath in the meantime, and the period of revolution of these successive braking ellipses affect very much the point where you finally wind up beginning your final retardation path.

On the other hand, choosing different braking ellipses can be used as a very good tool for timing your re-entry because ultimately you want to land at a predetermined spot.

I think this whole interaction between heat transfer and timing of a returning vehicle that comes back, say from the moon, so that it finally can land in the Caribbean, or somewhere, is something that requires a very careful study. The question of a lunar landing vehicle capable of reascent should be studied. Special problems connected with the cabin should be studied -- as is pretty obvious -- temperature control, meteor protection, radiation hazards, air, food supply, et cetera. And a study on actual construction of a deep-space vehicle

[REDACTED]

from final stages of such a carrier, as JUNO V should be studied. In other words, is it possible to use the top stages of, say, a JUNO V in the assembly of a deep-space vehicle? If so, what would be the optimum design for the ascent-space vehicle.

The objective of the first manned lunar expedition should be carefully studied. Somebody should start thinking about what are we going to do on the moon once we get there.

Finally, emergency capabilities should be studied. Now, here is a problem: Suppose we have an expedition stranded on the moon. Can you send oxygen or food or emergency equipment on a one-way trip to that stranded expedition? It is rather like dropping supplies to an expedition stranded in the Arctic.

Finally, guidance and control requirements must meet these capabilities; and a study of this field in terms of the available resources of the space station, use of television, and so forth, is necessary.

This ends my presentation.

I would like to introduce Dr. Stuhlinger.

DR. SILVERSTEIN: Are there some questions here about this presentation?

It is very fine. I think you bring out a very important point there in this return from the hyperbolic velocity here.

We visualize the atmosphere around the earth as pretty thin. and you are coming in at extremely high speed, trying to skim into this atmosphere. It is really a guidance problem of the first order, certainly.

DR. VON BRAUN: Well, the advantage is that you have plenty of time to do it provided you get the intelligence early enough.

QUESTION: I would just like to reiterate from the ARPA viewpoint, this vehicle is to perform any mission which is required of it with any seven out of the eight engines working. This penalizes us to the extent of from 3 to 5 percent propellant-wise, but we feel it is worth doing from the standpoint of ultimate mission reliability.

VEHICLE COMPONENTS AND RESEARCH OBJECTIVES

By

Dr. Ernst Stuhlinger



## VEHICLE COMPONENTS AND RESEARCH OBJECTIVES

DR. STUHLINGER: I am afraid I have to cut my talk a little short because we are fairly far advanced in our time schedule.

We believe that the program of vehicles as shown and discussed in the previous talks will be justified only if it can be matched by an equivalent program of missions and objectives.

The main objective in outer space, of course, should be man in space; and not only man as a survivor in space, but man as an active scientist, a man who can explore out in space all those things which we cannot explore from the earth.

For the sake of this discussion, I have listed here again the highlights of a space program in very short terms (Chart 64) beginning with vertical probes and ending with solar probes, going through satellites, lunar probes, and planetary probes.

The satellites are subdivided again, for the sake of this discussion, into three families -- the small satellites, medium satellites, and large satellites -- which match, more or less, the discussion in the previous talks (Chart 65).

It appears to us that a program of this kind needs a very intensive effort in two major areas. These two major areas are, first, the investigation and development of components and sub-components as needed for the space vehicles and for keeping men alive; the second of these two areas is scientific research, which will bring us knowledge and information of the new environment which space offers to our vehicles.

The first, development of components and sub-components, we will discuss with the help of three charts (Charts 66, 67, and 68).

On the first (Chart 66), we see a group of investigations which refer to materials, materials under the environmental conditions of space.

I would like to mention that all of these material properties which are listed are properties which have not yet been investigated. First, because it was not necessary -- we had no conditions on earth so far

# HIGHLIGHTS OF SPACE PROGRAM

---

130

- ① VERTICAL PROBES
- ② SATELLITES
- ③ LUNAR PROBES
- ④ LUNAR LANDING
- ⑤ DEEP SPACE PROBE
- ⑥ PLANETARY PROBES
- ⑦ PLANETARY LANDING
- ⑧ SOLAR PROBES

# SATELLITES FOR RESEARCH & COMPONENT DEVELOPMENT

<b>SMALL SATELLITES</b>	<b>20-200 LB</b>	<b>1958</b>
<b>MEDIUM SATELLITES</b>	<b>500-2000 LB</b>	<b>1959</b>
<b>LARGE SATELLITES</b>	<b>4000-20,000 LB</b>	<b>1961 1963</b>

# SPACE TECHNOLOGIES I

## MATERIALS

132

METALS – VAPORIZATION, VACUUM STICKING  
PLASTIC – EMBRITTLEMENT, DECOMPOSITION  
SEALANTS – DECOMPOSITION  
INSULATORS – DEPRECIATION  
BEARINGS – FRICTION, WEAR  
LUBRICANTS – VAPORIZATION, DECOMPOSITION  
MOVING PARTS – FRICTION, WEAR  
FLEXIBLE PARTS – STIFFENING, WEAR  
SURFACES – DECOMPOSITION, FROSTING  
COATINGS – EMISSIVITY, ABSORPTIVITY, REFLECTIVITY  
DIELECTRICS – DECOMPOSITION

FILE NO 701-5  
10 DEC 58

Chart 66





# SPACE TECHNOLOGIES III

## COMPONENT DEVELOPMENT

AUXILIARY POWER SUPPLIES

MEGAWATT POWER SUPPLIES

SPACE SUITS, AIR LOCKS, ETC.

CRYOGENIC EFFECTS

STORABLE PROPELLANTS

## ADVANCED PROPULSION SYSTEMS

O<sub>2</sub> + H<sub>2</sub> ENGINES

NUCLEAR FISSION ENGINES

ION ENGINES, ELECTROSTATIC

ION ENGINES, ELECTRODYNAMIC



which are equivalent to those in space; and second, we had no chance to investigate them because we have had no facilities thus far in which all the environmental influences -- like high vacuum, heat cycling, cosmic radiation, meteors, and so forth -- were acting at the same time.

I would like to take just one example from this list. Nobody knows, for example, how to build a bearing which can live and work in space over an extended period of one or two years, carrying a load, without excessive friction, hot spots, and so forth. We do not know what kind of lubricants it will take. This is certainly something that should be investigated, not only in the laboratory, but finally on a satellite in which we can test it under actual space conditions.

The second group of space technologies which we would like to discuss are the hazards in space as listed here (Chart 67). Again, I would like to mention just one or two. Recently it was discovered with the Explorer satellites that there is an extremely intense radiation out in space. It is known as the Van Allen Radiation Belt. This radiation is much more intense than previously anticipated; and the measurements of our lunar probe -- though it was only half successful as a lunar probe, was fully successful as a radiation measuring probe -- indicate that the radiation at an altitude of about 10,000 miles is very much greater than the highest intensity measured by Explorer IV.

We have to measure and study this radiation, and in particular, we have to find means of protection for our instruments, as well as for the men who are to live under these conditions.

Again we cannot hope to solve the problem entirely by only making experiments in the laboratory. We must go out into space, with satellites to test out our protective devices for instruments, for animals, and finally for man himself.

We also believe investigation is vitally needed in the third group of space technologies. As shown in Chart 68, we see a number of components. Problems in connection with these, you will agree, will



have to be investigated and studied before we can have an efficient and successful space flight.

I will mention only a few items. Note, for example, auxiliary power supplies. We at ABMA endorse wholeheartedly the program which is under way at the AEC. We believe the SNAP II will be ideal for satellites capable of 10,000 to 20,000 pounds payload. But, we feel that 3 KW is not yet sufficient for application on larger satellites.

For example, think of transmitters which must transmit messages from 24-hour satellites which at the same time, must be coded, and which might even have to penetrate deep layers of sea water to reach a submarine.

We recently wrote a letter to AEC requesting that agency to expand its program to incorporate power supplies of about 25 KW. We even believe that this should not be the limit, but that larger power supplies should be taken up in this program.

Megawatt power supplies, of course, will be needed when we go into electrical propulsion systems, electrostatic or electrodynamic, which we believe hold a very great promise for the future.

Space suits, air locks, and so on, have been mentioned by Dr. von Braun and I think it is understandable that they require research and development work.

Now, here is one field, cryogenic effects, in which we are particularly interested at ABMA, and we even feel that here a kind of gold mine is opened for the future space traveler.

By "cryogenic effects," we mean all these effects which show up at very low temperatures when we are close to the absolute zero point in the temperature scale.

The best known of the low temperature effects, of course, is superconductivity. By "superconductivity," we mean the fact that certain metals and alloys lose their electrical resistance completely at low temperatures. This means that Ohm's law is no longer applicable to superconductors; we have to use the laws of induction to learn what is going on in an electric circuit.



It further means that we can induce in a superconductor, for example, a ring current which flows practically forever without further support. The superconducting sample can then be carried by another magnet without any material contact with it.

Now, when we evacuate the container of such a device, we can avoid any friction of the superconducting sample. The vacuum, of course, is available for free in space; and so we see immediately that we can construct on this principle a floating body which is held in position by means which do not touch it and which, therefore, can rotate without any friction. Such a body would lend itself ideally to the design of advanced gyroscopes.

Actually, we could even kill two birds with one stone. First, there is no friction which would make the gyro deviate; and second, we can keep the gyro rotor spinning practically without power input. In short we could design a gyroscope with excellent accuracy and almost without power consumption. This is just one example.

ABMA has, at the present time a small, modest contract with General Electric who has been pioneering in this field during the last year. GE has had and also has now superconductivity gyroscopes running. They display the expected effects to the full satisfaction of the designers.

We can already say that a gyroscope of this kind would be about 100 times more accurate than our best gyroscopes at present, and that the power supply, i.e., the residual power which is needed to keep it going, would be less than one thousandth of the power needed for normal gyroscopes.

Now, there are some more striking effects at low temperatures. For example, oscillating circuits for electronic instruments can be built with extremely low losses; that means that the resonance, the sharpness of the resonance can be made extremely high, much higher than we can make it with conventional means.

Another possible application would be in cavity resonators for high frequency generation; and theory at least indicates that the quality

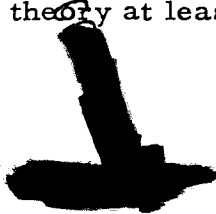



of these cavities would be at least as good, if not even better, than the accuracy and the stability, of the best atomic clocks we have today.

Another element which can be built on the principle of superconductivity would be a memory, a little magnetic memory. A very small superconducting element can be utilized for a magnetic memory with an extremely long lifetime and with excellent resistance against deterioration.

What we have in mind here is a kind of package, space package, which is put into a container of liquid hydrogen or helium to be kept cool, and which would contain all the superconducting guidance and control elements which we need for space travel: accelerometers, gyroscopes, receivers, transmitters, computers, memories, and so forth - all of which profit from the striking effects of superconductivity.

I would like to mention here that Professor Von Karman himself the other day mentioned that the successful engineering of instruments on the basis of superconductivity in his opinion is the real door to space flight. He said that once we have solved this problem, we can, with confidence, prepare to make long trips through space with manned vehicles.

Another effect which would be extremely favorable here is the elimination of corrosion at low temperatures.

The motion of molecules is just so slow that no corrosion takes place, and this again would help to make instrument life much longer than on the ground.

Let me touch the other subjects only briefly.

JPL has started a development program for storable propellants, which again we would like to endorse wholeheartedly. In fact, Mr. Koelle mentioned the 6K engine with storable propellants as one integral part of our vehicular program. We would like to encourage also the investigation and development of larger units on the basis of storable propellants. Storability should also be investigated with respect to such problems as patching and repairing of tanks after being hit by a little meteor, or corrosion of seals in valves, and so on, as well as with respect to vaporization and decomposition.



Regarding advanced propulsion systems, we have tried to keep abreast of the developments of H<sub>2</sub> and O<sub>2</sub> engines, and of fluorine engines. But, as far as we see, not enough investigations have been made as yet to decide definitely between hydrogen and fluorine engines. Both of them seem to perform about equally. Hydrogen may be slightly better, but the handling features and potential hazards are not sufficiently known to say for sure whether hydrogen is preferable to fluorine. We would recommend that both types be developed further.

Regarding nuclear engines, we have tried to keep informed of the developments. What we can say so far is this: If the hopes which are behind these developments materialize, that means if we have one day specific impulses of 800 to 900 seconds, and if at the same time the cooling problem and the hazard problem have been solved, these engines would be ideally suited for second stage and as interplanetary propulsion units. However, we feel that much more work has to be done, particularly with respect to materials for these engines. Full attention must be given to hazards, to shielding, and so forth before one can finally decide whether nuclear engines will be useful and practical.

The most promise for nuclear engines at present appears to be in the field of smaller sustainer motors with thrusts of a few thousand pounds. These will operate for as long as hours or even days on interplanetary trips. In that case, the shielding and cooling problems would be much easier than with an engine providing some hundred thousand pounds of thrust.

We believe that our efforts in this space technology field should be as great as possible. We even are of the opinion that if we fail to come up with answers and solutions to space-technology problems, then our entire space program may come to a dead end, even though we may have the vehicles to carry our payloads aloft. So we wish to recommend a very powerful effort in this field of space technology.

Speaking of the second major area which I mentioned, that of scientific research, Chart 64 refers to a number of vehicles, such as





vertical probes, satellites, lunar vehicles. We may go briefly through the scientific and technical problems which can be solved with these vehicles.

Vertical probes (Chart 69) will serve to explore mainly the effects and implications of outer space from a scientific standpoint. Furthermore, they help us to improve and perfect our tracking techniques.

As shown in Chart 70, small satellites will, more or less, do the same with the benefit of much longer observation time. We are at the present time in full swing with the investigations by exploitation of small satellites. A number of excellent scientific investigations can be made; but, of course, small satellites will, by no means, replace or make unnecessary the larger satellites.

With the small ones, we can again, in addition to scientific investigations, study tracking techniques and improve and perfect orbital computation methods.

To some extent, we have done that with the Explorer and the VANGUARD satellites; but much more work is necessary. We recommend that more small satellites be launched in the near future.

At the present time, ABMA has satellite assignments by NASA in the form of the JUNO II program.

Medium satellites (Chart 71) will be launched by ICBM-type vehicles of the ATLAS and TITAN type. They will carry out more scientific observations with more elaborate apparatus. A few more will be made. We can also make space technology investigations of the kinds which were mentioned previously, such as material testing, component testing, and so on; and can also test re-entry techniques which, of course, are of vital importance for manned flight.

With the last satellite class, the ones which are launched by vehicles of the JUNO V type (Chart 72), we believe that we are really in business. They allow us to make the first decisive step toward manned flight, which is, of course, our final objective. First, we can investigate and develop a number of components which lead to manned

# **TEST OBJECTIVES**

---

**VERTICAL PROBES: 15...50 LB.**

**50,000...150,000 MILES**

**1958...**

**COSMIC RADIATION**

**RADIATION BELT**

**MAGNETIC FIELD**

**SOLAR RADIATION**

**METEORITES**

**TRACKING TECHNIQUES**



# TEST OBJECTIVES

142

SMALL SATELLITES : 20..200 LB.  
1958...

UPPER ATMOSPHERE

SOLAR & SPACE RAD.

METEORITES

MAGNETIC FIELD

WAVE PROPAGATION

TRACKING TECHNIQUES

ORBIT COMPUTATION

## TEST OBJECTIVES

MEDIUM SATELLITES : 500..2000 LB.  
1959...

SCIENTIFIC OBSERVATIONS ,  
MORE ELABORATE  
ASTRONOMICAL OBSERVATIONS  
TV OBSERVATIONS OF EARTH  
COMMUNICATIONS  
MESSAGE CARRIER ("MAILBAG")  
SPACE TECHNOLOGIES  
RE-ENTRY TECHNIQUES

# TEST OBJECTIVES

---

LARGE SATELLITES, 4,000-20,000 LB  
1961 / 1963

DEVELOPMENT OF HUMAN CAPSULES

RE-ENTRY TECHNIQUES

MANNED FLIGHT

SCIENTIFIC OBSERVATION, MANNED SPACE STATION

LARGE TELESCOPES

ELABORATE WEATHER SATELLITES

24-HOUR SATELLITES

HIGH POWER COMMUNICATIONS

TESTING OF ADVANCED ENGINES

SPACE TECHNOLOGIES

ASSEMBLY AND LAUNCHING OF SPACE VEHICLES



flight, such as large human capsules. Second, actual manned flight will be possible with JUNO V type vehicles.

Even medium satellites will be able to accommodate a man, to keep him alive for a few hours, and to bring him down to earth again; but he will not do more than just survive in space. What he should do is to feel comfortable and to observe and accomplish some work. He should be there as a scientist and bring back to earth all the answers which we cannot get otherwise. He can do that on a satellite of this size; and, therefore, we believe that this development will be the first really decisive step towards the exploration of space.

A number of other objectives are listed here; I would like to discuss only a few of them.

The 24-hour satellite is one which we believe should be relatively heavy, about 5,000 pounds. The reason for it is that the 24-hour satellite, to be efficient, needs a number of standard equipment components like an attitude control system; a control system to correct its velocity so that it is exactly a 24-hour satellite; a power supply which generates enough power for efficient communication, for coding, and so on. It must have antennas which may be fairly heavy. Therefore, we believe that the 24-hour satellite will come into existence only when we have the heavy weight capability of a JUNO V type vehicle.

Space technologies will be of utmost importance among the observations on large satellites. It will be necessary, for example, to try out on these heavy satellites power supplies which we will later use on the moon. We will certainly not dare to send a power supply to the moon before this same power supply has worked efficiently and successfully for months or even years on a large satellite. By testing the power supply on a satellite, we have the benefit of being close to it so that we can observe its operation at all times.

Assembly and launching of space vehicles is also something which we can do and must do from large manned satellites.





There are a few more objectives of large satellites which I would like to mention before we go to the next chart. One of them refers to crew training.

We are very happy to see that NASA recently started a program in crew training and crew selection.

One of the problems of crew training which we believe can be attacked as soon as we have larger satellites is that of psychologic strain. I do not believe that we will send a crew on a trip to Mars before the same crew has been living together on a large satellite under weightlessness for an extended period, of months or half a year. Four men should not be sent to Mars on a two-year trip until the same four men have proven that they can live together under the effects and implications of space and in the artificial environment of a space capsule, or on a satellite for a long time.

If they cannot live together, they can be taken out of a satellite within a few hours and can be put back into a normal environment. When they go to Mars, this cannot be done. So they certainly should try and prove their compatibility under the satellite conditions before they start the big journey.

Now, as soon as we consider flights to the moon or to planets, there are a number of new objectives (Chart 73). I would like to discuss only a few of them.

Before we make a landing on either the moon or a planet, particularly on a planet we would, of course, like to know as much about the surface as possible. This can be achieved with satellites around the moon or around planets equipped with television and other optical instruments; this must be done to the fullest extent before we can prepare for a manned landing.

We also recommend, and I think this should by all means be done, that projects be planned to have men on satellites around the moon or planets to observe directly and personally all they can possibly see of the surface of the moon or the planets. We must not forget that even our best instruments will always be prepared only

# LUNAR EXPLORATIONS

PROBE TYPE	EXPERIMENTS							PARALLEL INVESTIGATIONS STUDY AND DEVELOPMENT			
LUNAR AREA PROBE	STUDIES	FIELD	MOONS MASS	MICROMETEORITES			SYSTEMS	HARD LANDING INSTRUMENTATION LUNAR SURFACE PHENOMENA SURFACE VEHICLES INSTALLATIONS (STUDY)			
HARD LANDING PROBE			LUNAR SURFACE CHARACTERISTICS	MICROMETEORITES	MOONS STRUCTURE	TEMPERATURE	LUNAR ATMOSPHERE	RECONNAISSANCE	SOFT LANDING INSTRUMENTATION CLOSED BIOLOGICAL CYCLES		
SOFT LANDING PROBE	RADIATION	MAGNETIC	GRAVITY	LUNAR SURFACE CHARACTERISTICS	MICROMETEORITES	MOONS STRUCTURE	TEMPERATURE	LUNAR ATMOSPHERE	RECONNAISSANCE	SYSTEMS	SURFACE VEHICLES AND INSTALLATIONS
LUNAR SATELLITE	RADIATION	MAGNETIC	GRAVITY	LUNAR SURFACE CHARACTERISTICS	MICROMETEORITES	MOONS STRUCTURE	TEMPERATURE	LUNAR ATMOSPHERE	RECONNAISSANCE	SYSTEMS	



for observations and measurements which we can anticipate. Only men can observe and record things which had not been expected in advance.

This is a difference between instruments and men which we should remember all the time. There is no substitute for the exploring and the discerning mind of a living scientist.

I do not believe that we can obtain a comprehensive picture of the moon or the planets before we have men there, at least in satellite orbits.

They should explore landing possibilities, and once they have landed on the moon or a planet, they will make all these observations on the surface which no instrument, however elaborate it may be, could accomplish.

I think I should mention briefly our opinion about at least one objective which arises when we consider a space program.

One of them is the large, single barrel engine of the 1.5 million pounds thrust class. We wish to endorse and recommend this development to the fullest extent, and we believe that its main merit will be in providing us a clustered engine for heavy loads of as much as about 5 million pounds take-off weight. Of course, such a clustered engine will be very useful for vehicles that carry larger space probes to the moon and to the planets. It also will have a considerable capability for hauling heavy payloads into orbit.

Components of space stations and of space ships will be heavy, and only where we have powerful carrier vehicles will we be able to carry them aloft.

Now I would like to repeat in a few sentences what we wish to recommend.

We believe that a major effort must be made as soon as possible in two areas: in the development of components, and in scientific research.

We recommend that these two areas be vigorously attacked as soon as possible.





We also would like to mention that ABMA has initiated investigations and even contracts in some of these fields.

We would like to request NASA to support these activities of ABMA's in the future, because we believe that we can make a considerable contribution to the NASA space program.



DISTRIBUTION

ORDAB-X	Commander
ORDAB-C	Chief, Control Office (20)
ORDAB-D	Dr. von Braun
ORDAB-D	Mr. Rees
ORDAB-D	Mr. Dannenberg
ORDAB-D	Mr. Rudolph
ORDAB-D	Mr. Saurma
ORDAB-D	Mr. Constan
ORDAB-DA	(6)
ORDAB-DC	Dr. Lange
ORDAB-DC	(3)
ORDAB-DF	(6)
ORDAB-DG	(8)
ORDAB-DL	(6)
ORDAB-DM	(8)
ORDAB-DV	(8)
ORDAB-DR	(6)
ORDAB-DT	(6)
ORDAB-DS	(2)
ORDAB-DSRA	(2)
ORDAB-DSRW	(2)
ORDAB-DSL	(3)
ORDAB-DSD	(5)
ORDAB-DSF	(5)
ORDAB-DSN	(2)
ORDAB-DSP	(10)
ORDAB-DST	(1)
ORDAB-DSC	(1)
ORDAB-DIR	(1)

(Additional copies are available through  
ORDAB-DSP, extension 4714.)

AA 59752/15 Dec  
Cir on C-AA59752

APPROVAL FOR D-TN-1-59:

*H. H. Koelle*

---

H. H. KOELLE  
Chief, Future Projects Design Branch

*Ernst Stuhlinger*

---

ERNST STUHLINGER  
Director, Research Projects Laboratory

*Wernher von Braun*

---

WERNHER VON BRAUN  
Director, Development Operations Division