

13 October 1958

Report DSP-TM-10-58

~~CONFIDENTIAL~~

ARMY

BALLISTIC MISSILE AGENCY

REDSTONE ARSENAL, ALABAMA

II.07

429-2333-117



JUNO V SPACE VEHICLE
DEVELOPMENT PROGRAM (PHASE I):
BOOSTER FEASIBILITY DEMONSTRATION

ORDERS

RECEIVED
14 OCT 58
22

Technical
DO NOT DESTROY

DOWNGRADED AT 3 YEAR INTERVALS
DECLASSIFIED AT 10 YEAR INTERVALS
POD DIR 5802.10



FOR YOUR RETENTION
DO NOT RETURN TO DSIC

~~CONFIDENTIAL~~

4
"The material contained in this report has been published for information and possible use by other Government activities. It represents the results of work performed at the Army Ballistic Missile Agency and records a significant mark of achievement of the organization or individual whose name appears hereon. This report is NOT intended to indicate that the material contained herein has been fully evaluated, tested and accepted by this Agency or the degree to which it has been or may be used in accomplishment of the Agency mission."

~~CONFIDENTIAL~~
~~CONFIDENTIAL~~

13 October 1958

Report No. DSP-TM-10-58

JUNO V SPACE VEHICLE DEVELOPMENT PROGRAM
(PHASE 1): BOOSTER FEASIBILITY
DEMONSTRATION

By

H. H. Koelle, F. L. Williams, W. G. Huber, R. C. Callaway, Jr.

FUTURE PROJECTS DESIGN BRANCH
STRUCTURES AND MECHANICS LABORATORY
DEVELOPMENT OPERATIONS DIVISION
ARMY BALLISTIC MISSILE AGENCY
REDSTONE ARSENAL, ALABAMA

"Regrading Data Cannot Be Predetermined"

~~CONFIDENTIAL~~
~~CONFIDENTIAL~~

[REDACTED]

~~CONFIDENTIAL~~

~~CONFIDENTIAL~~

SECURITY NOTE

This document contains information affecting the national defense of the United States within the meaning of the Espionage Law, Title 18, U.S.C., Section 793 and 794, as amended. The transmission or revelation of its contents in any manner to an unauthorized person is prohibited by law.

~~CONFIDENTIAL~~

~~CONFIDENTIAL~~

[REDACTED]

~~CONFIDENTIAL~~

~~CONFIDENTIAL~~

ABSTRACT

The initial phase of the JUNO V space vehicle development program, as presented herein, provides for a static demonstration and a total of four flight feasibility tests. The latter two flights will give the U. S. its first payload capability in excess of 10,000 lb in mid 1961. The objective of the overall program is to provide a reliable, economical, and flexible carrier vehicle with relatively large payload capability for orbital and space missions at the earliest possible date.

This report gives the design philosophy used as well as a description of the booster and the interim two-stage test vehicle which will be used for flights number 3 and 4. In addition, preliminary details of possible upper stage configurations, weight breakdowns, and performance characteristics are presented.

Because of the large payload capabilities offered by the JUNO V many possible missions can readily be envisioned and these are outlined along with their potential users.

Operational aspects such as static test requirements, handling and transportation considerations, fabrication procedures, and launching site requirements are also discussed in detail along with engineering, test, and flight schedules.

Based on the results of present studies it appears feasible to design, develop, static test, and launch four JUNO V single and two stage engines by the end of CY 1961 within the total funding of \$72 million.

It will, however, be necessary to take immediate action to insure the required development procurement and testing of the second stage to meet this schedule.

~~CONFIDENTIAL~~

~~CONFIDENTIAL~~

ACKNOWLEDGMENT

The authors hereby acknowledge the excellent cooperation and contributions from the following Development Operations Division Laboratories:

COMPUTATION LABORATORY
FABRICATION AND ASSEMBLY ENGINEERING LABORATORY
GUIDANCE AND CONTROL LABORATORY
MISSILE FIRING LABORATORY
STRUCTURES AND MECHANICS LABORATORY
SYSTEMS SUPPORT EQUIPMENT LABORATORY
TEST LABORATORY

In addition, the following sections of the Future Projects Design Branch were particularly helpful in conducting the preliminary studies required and preparing the necessary artwork:

Graphic Engineering and Model Section
Missile System Analysis Section
Missile Design Section
Astronautical Engineering Section
Missile Evaluation Section

Acknowledgment is also made of the assistance of the following individuals:

Mrs. Hazel G. Lansing, Compilation and Editing
Mrs. Rose K. Mottar, Compilation and Editing
Mrs. Geneva P. Jackson, Repro Copy

TABLE OF CONTENTS

	Page
ABSTRACT	iii
ACKNOWLEDGMENT	iv
TABLE OF CONTENTS	v
LIST OF ILLUSTRATIONS	viii
I. INTRODUCTION	1
II. JUNO V SPACE VEHICLE DEVELOPMENT PROGRAM	4
A. Proposed Designation	4
B. Program Objective	4
C. Potential Users and Missions	4
D. System Parameters	6
III. DESIGN APPROACH	7
A. Primary Design Parameters	7
B. Propulsion System (Cluster vs. Single Engine)	7
C. Tankage Design	9
D. JUNO V Staging Considerations	11
E. Guidance and Control	14
F. Booster Recovery	16
G. Upper Stage Design Criteria	17
H. Mobility and Flexibility	19
I. Crew Safety and Reliability	20

TABLE OF CONTENTS (Con't)

	Page
J. Growth Potential	22
K. Manufacturing Considerations	24
IV. DESCRIPTION OF JUNO V SPACE VEHICLE	25
A. Booster Configuration	25
B. Interim Two-Stage Test Vehicle	27
C. Promising Multistage Vehicle Configurations	28
V. PHYSICAL CHARACTERISTICS AND PERFORMANCE	33
A. Weight Breakdown	33
B. Preliminary Performance	33
C. Volume Considerations	38
D. Space Missions	39
VI. OPERATIONAL CONSIDERATIONS	44
A. Test Stand Operations	44
B. Fabrication and Assembly	46
C. Launching and Handling Considerations	47
D. Launching Facilities	53
VII. SCHEDULE	58
A. Captive Firing of JUNO V Booster	58
B. JUNO V Flight Test Program	58
VIII. SUMMARY	62
IX. CONCLUSIONS AND RECOMMENDATIONS	64

TABLE OF CONTENTS (Con't)

	Page
A. Conclusions	64
B. Recommendations	65
REFERENCES AND BIBLIOGRAPHY	68
APPENDIX A	71

~~SECRET~~

TABLE AND FIGURES

Table		Page
1	JUNO V Performance and Weight Information	34
Figure		
1	Comparison of 1.5 Million Lb Thrust Clustered and Single Engine Designs	8
2	Comparison of Possible JUNO V Booster Tankage Designs	10
3	Parallel Staging Design for JUNO V	12
4	Conventional Staging Design for JUNO V	13
5	JUNO V Guidance and Control Requirement	15
6	Parachute Recovery of JUNO V Booster	18
7	Air-Transportable JUNO V Booster	21
8	Promising Growth Potential of JUNO V Booster	23
9	JUNO V Booster	26
10	JUNO V Two-Stage Flight Test Vehicle	29
11	Promising JUNO V Three-Stage Configuration With 30,000 Lb Payload	30
12	JUNO V Payload Capabilities Versus Altitude	36
13	JUNO V Payload Volume Requirements	40
14A	JUNO V Payload-Mission Capabilities (Ballistic Transport)	41
14B	JUNO V Payload-Mission Capabilities (Space Mission)	43
15	JUNO V Booster on ABMA Test Stand	45

TABLE AND FIGURES (Con't)

Figure		Page
16	JUNO V on Launching Platform	48
17	JUNO V Vehicle Launching	49
18	JUNO V Booster Hold-Down Devices for Launching	50
19	Erection of JUNO V Two-Stage Flight Test Vehicle on Launcher	52
20	Recommended JUNO V Launching Site	56
21	JUNO V Booster Captive Firing Schedule	59
22	JUNO V Flight Test Program Schedule	60

~~SECRET~~

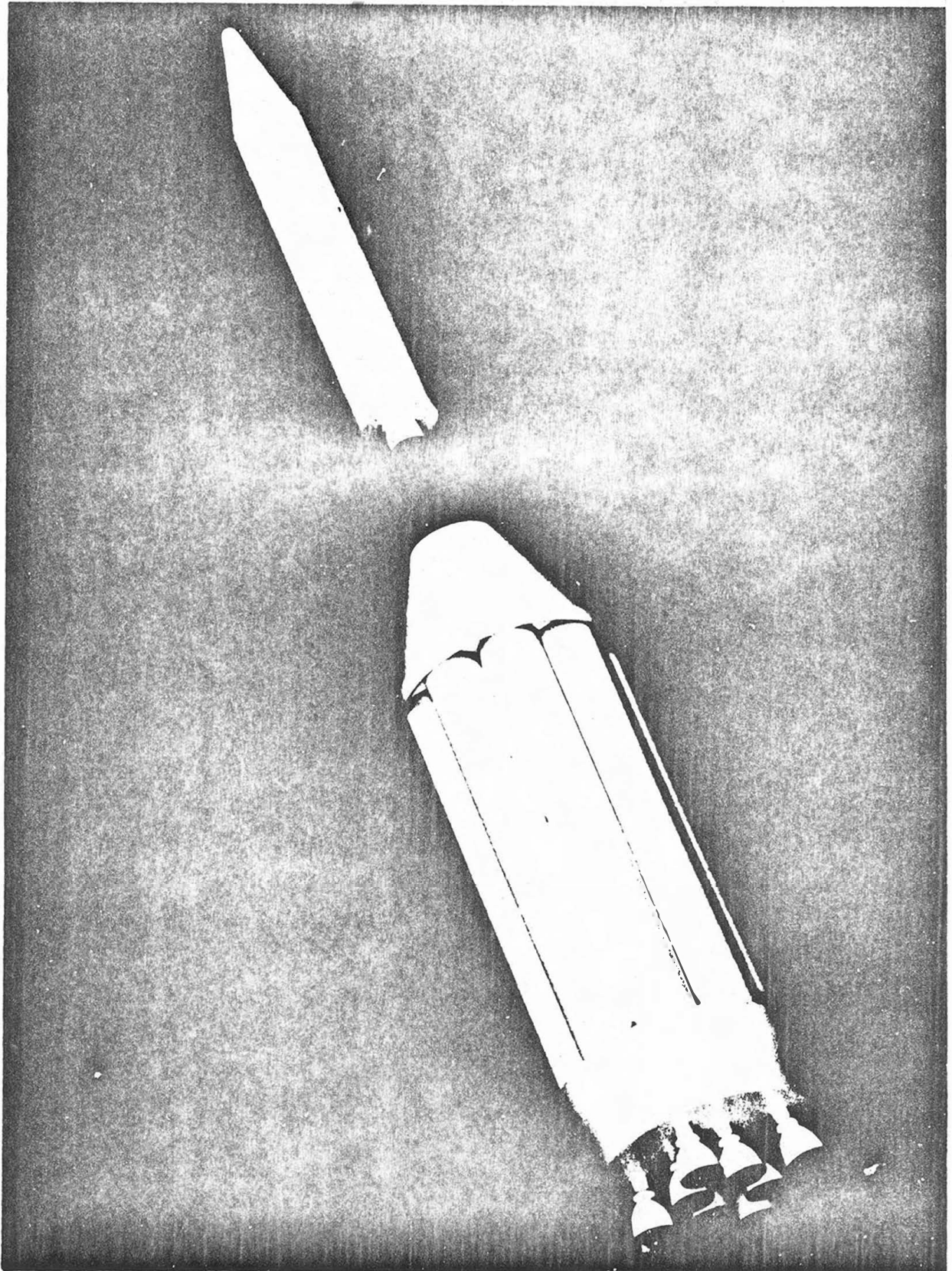

~~SECRET~~

I. INTRODUCTION

The present state of the art in the field of orbital carriers in the United States is represented by the VANGUARD and the JUNO I (JUPITER-C) vehicles. These require approximately 1000 and 2000 lb, respectively, of take-off weight per pound placed in orbit. This results in a transportation cost of approximately 1,000,000 \$/lb for the VANGUARD and 100,000 \$/lb into orbit for JUNO I, if the experienced reliability is taken into account.

The present satellite carriers on order, but not yet successfully flown (JUNO II, THOR-117L, JUNO X (JUNO IV), and ATLAS-117L), will reduce the growth factor gradually to about 100-lb take-off weight per pound placed in orbit and the cost to about 3000 \$/lb. However, the maximum payload capability of the orbital carriers above, without use of high-energy propellant, will be limited to about 3000 lb for the next two years. If required, use of high-energy propellants will extend the payload capabilities of ICBM-based orbital carriers to 5000 and possibly 10,000 lb by 1961/62.

The Army Ballistic Missile Agency was among the early groups who considered a payload capability of 20,000 to 40,000 lb for orbital missions and 6000 to 12,000 lb for escape missions as urgent requirements for space missions of the near future.

The Army Ballistic Missile Agency initiated studies on the booster required for this task in April 1957. These initial studies, based on a booster in the 1.5 million-pound thrust class, placed special emphasis on a propulsion system. At that time a cluster of four NAA E-1 engines, which were in the early stages of development, were considered. This booster, which in the beginning was designated the SUPER-JUPITER, and several upper stages were investigated by ABMA with the assistance of NAA. The total effort in this area from April 1957 until September 1958 was approximately 50,000 man-hours which enabled a fast start on this program. Reports resulting from these studies are listed in the bibliography.

In July 1958, representatives of the Advanced Research Projects Agency (ARPA), showed interest in a clustered booster with 1.5 million-pound thrust based on available engine hardware. The ARPA objective was to obtain a booster with approximately 1.5 million-pound thrust at the earliest possible date within the funding limitations. This requirement favored the choice of eight modified NAA JUPITER engines rather than four E-1 engines. This choice would result in a saving of approximately \$60 million and about 2 years development time.

The vehicle based on this booster was given the unofficial designation JUNO V by ARPA. This vehicle will have an initial growth factor of about 50

~~SECRET~~

which can further be reduced to 25 by use of high-energy propellants, and to about 10 by use of a nuclear-powered upper stage. The transportation cost can hopefully be reduced to 100 \$/lb payload by means of booster recovery in due course of development.

ABMA's experience in the field, plus the availability of facilities and manpower, led to ARPA Order Number 14-59, dated 15 August 1958. The scope of this order is given in the following excerpt:

"Initiate a development program to provide a large space vehicle booster of approximately 1,500,000-lb thrust based on cluster of available rocket engines. The immediate goal of this program is to demonstrate a full-scale captive dynamic firing by the end of CY 1959."

Further studies for the extension of the big booster program past the feasibility demonstration resulted in a memorandum of agreement signed by Mr. R. W. Johnson, Director of ARPA, and Maj. Gen. J. B. Medaris, Commanding General of AOMC, on 23 September 1958. This memorandum provides for an extension of the program to include four booster test flights. The first two flights will be booster propulsion flight tests and the latter two flights will be with a second stage which will provide limited orbital capability. AOMC is required to submit to ARPA not later than 15 October 1958 a detailed development and funding plan based on this agreement. (See Appendix A for copy of memorandum.)

This report outlines the suggested development program based on the available funds. Funding limitations make this program a compromise from a desirable development program required to meet the national need at the earliest date.

Presented herein are a list of potential users and missions for the JUNO V vehicle, the design approach that was used in arriving at the proposed configuration, a description of the booster and the two-stage interim test vehicles. Also other promising upper-stage combinations, a weight breakdown and preliminary performance calculations, operational considerations dealing with the test stand, assembly, transportation, and launching operations and finally a program schedule are discussed.

The OBJECTIVES OF THE REPORT are summarized in these two points:

A. To familiarize all organizations and personnel within the development team with the required task including assumptions, suggested approach, anticipated development problems, and schedule.

B. To inform the potential users of the expected capabilities and availability of the JUNO V, as well as the technical details of the design configuration as presently envisioned.

~~SECRET~~

II. JUNO V SPACE VEHICLE DEVELOPMENT PROGRAM

A. Proposed Designation

Although not yet approved, the popular name proposed by Dr. von Braun for the space vehicle resulting from the JUNO V development program is "SATURN". The SATURN is considered to be the first real space vehicle as the Douglas DC-3 was the first real airliner and durable workhorse in aeronautics. It is expected that the JUNO V vehicle will serve all national and possibly international space programs as the workhorse for more than a decade.

B. Program Objective

The objective of the program is to develop for operational use a reliable, economical, and flexible carrier vehicle for orbital and space missions within the shortest possible time. The orbital payload capability should be in the 20,000 to 40,000-lb class and, for escape and similar missions, in the order of 5000 to 10,000 lb. The space vehicle under consideration should also have a capability to carry at least 1000 lb of useful instrumentation for soft-landing missions on the Moon or Mars.

C. Potential Users and Missions

The following organizations are considered as potential users with possible missions listed accordingly:

1. ARPA, as representative of the Department of Defense for all military services:

a. Carrier vehicle for research and development of offensive and defensive space weapons.

2. U. S. ARMY

a. Orbital carrier vehicle for space defense missions against offensive enemy space vehicles.

b. Orbital carrier vehicle for communication and meteorological satellites.

c. Emergency supply carrier for surface-to-surface supply operations such as:

(1) 300-mile single-stage carrier vehicle.

(2) 4000-mile two-stage carrier vehicle.

3. U. S. AIR FORCE

- a. Orbital carrier vehicle for the DYNA-SOAR III weapon system.
- b. Manned orbital carrier for man-in-space program.
- c. Orbital carrier for reconnaissance satellites.
- d. IRBM and ICBM for special missions with multiple nuclear, chemical, or conventional warheads and/or for transportation of propaganda material.

4. U. S. NAVY

- a. Orbital carrier for navigation satellites.

5. NASA

- a. Orbital carrier for scientific research by means of instrumented satellites.
- b. Space vehicle for the exploration of outer space, Moon, and planets.
- c. Orbital carrier for establishment and maintenance of civilian space stations.
- d. Flying test bed for F-1 engine, nuclear propulsion, and other systems.

6. UNITED NATIONS

The JUNO V space vehicle family might be offered as a carrier vehicle for any international space-flight program decided upon by the United Nations.

7. COMMERCIAL CUSTOMERS

It is anticipated that the economics of the JUNO V orbital carrier vehicle will approach the \$100 per pound figure by 1970 and attract private organizations for commercial applications of orbital transportation.

D. System Parameters

The JUNO V space vehicle system is considered a very important member, but only one member, of a family of carrier vehicles which must be available within the national military and civilian space organization.

Therefore, the "transportation system" point of view will be considered during the design phase of this vehicle. Among others, the following major points are being considered:

1. Reliability and safety
2. Economy
3. Early availability
4. Test facilities
5. Launching facilities
6. Propellant production capacities
7. Production requirements
8. Maintenance and serviceability
9. Logistics (general)
10. Mobility
11. Crew engineering and psychological factors
12. User requirements

All these items are subject to detailed investigation for the optimization of the transportation system under consideration.

III. DESIGN APPROACH

A. Primary Design Parameters

Reliability and crew safety play the primary roles in the development of this carrier vehicle since it is anticipated that it will be the first space vehicle to be used frequently for personnel transportation on a larger scale. In general, it is realized that this vehicle should approach aircraft reliability. Before men can be flown in this vehicle, a reliability of at least 90 per cent should be demonstrated. Proven hardware will be used where possible and weight penalties will be accepted to obtain the necessary reliability. Although economic considerations are generally considered overriding, reliability must not be sacrificed for economy and/or performance.

Performance and schedule are the next most important design parameters. As has been noted, the achievement of a large payload capability at the earliest possible date is one of the primary objectives of this development program.

Due to the large number of potential missions, firing rates up to about two per week are expected. Therefore, the recovery of the costly first-stage booster will be an economical requirement. Booster recovery will reduce the long-range program expenditure and, at the same time, will assist in obtaining good reliability at an early date.

These design parameters, as well as others, are discussed in the next several paragraphs.

B. Propulsion System (Cluster vs. Single Engine)

In order to fulfill the program objective of providing the U. S. with a large payload capability at the earliest possible date, the use of existing propulsion systems is mandatory. Since a booster thrust level of 1500K is desired and no single engine of this level is available, a cluster of smaller engines is required. A comparison of the two configurations is shown in Fig. 1. The required large-payload capability can be achieved 3 to 4 years earlier by this means.

The cluster concept also yields a shorter vehicle - this is desirable from structural design and launching preparations standpoint - and a simpler control system. Simplification of the control system results from the elimination of the requirement to gimbal an extremely large thrust chamber. In addition to the above design considerations, the clustered engine concept eliminates the immediate need for additional large test and production facilities and also reduces the handling and transportation problems associated with a large single engine.

~~SECRET~~

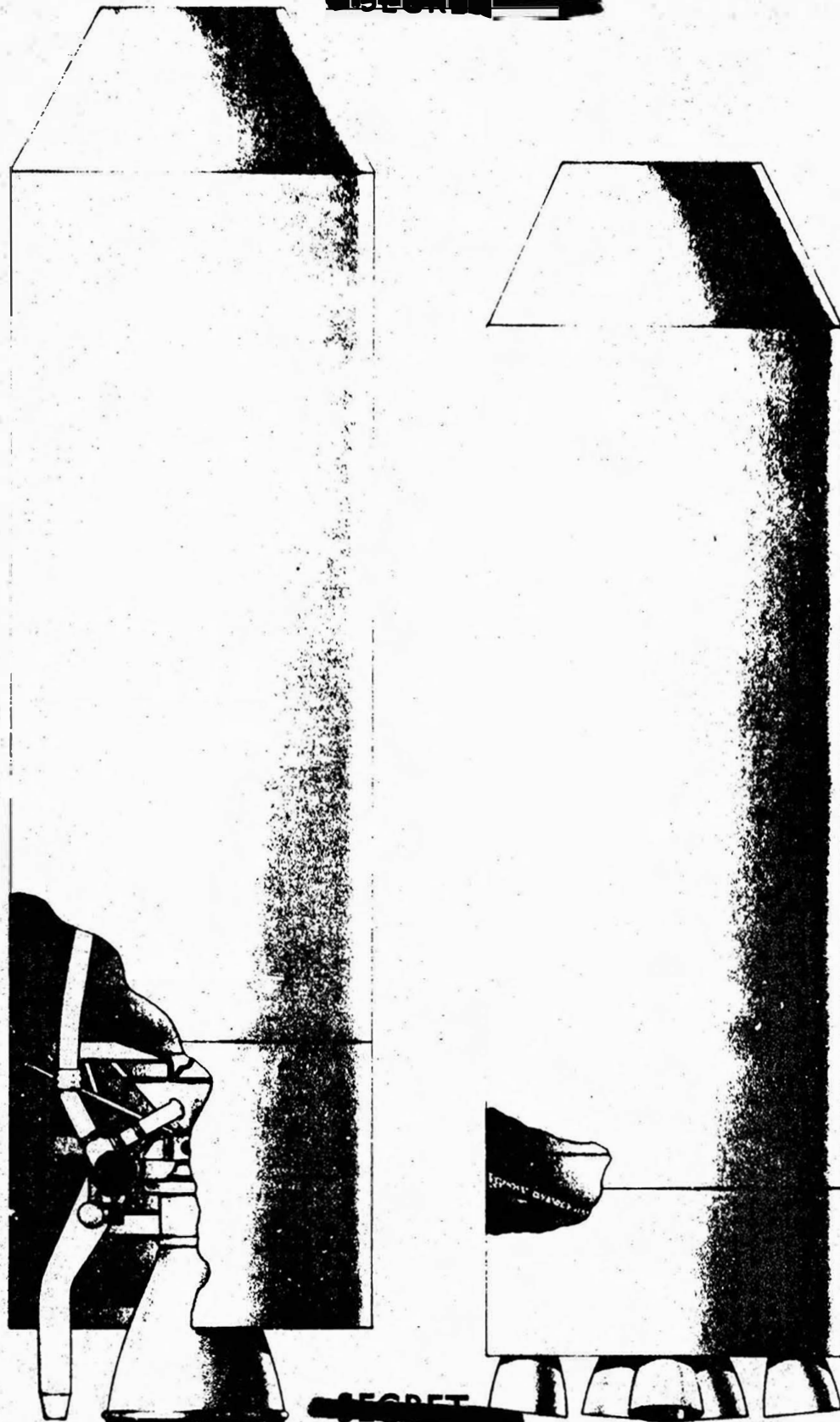

~~SECRET~~

COMPARISON OF 1.5 MILLION LB THRUST CLUSTERED
AND SINGLE ENGINE DESIGNS

FIG.1

A better chance of crew survival during booster powered flight is gained since failure of one engine does not render the entire vehicle powerless as would be the case with a large single engine. Failure of one engine would still permit the vehicle to accomplish a limited mission. Loss of 2 or 3 engines would still leave the vehicle controllable and provide adequate stability to allow crew bailout, which is a major design consideration. Considering the reliability of the clustered vehicle, it is believed that this method, since it employs existing smaller engines, offers greater safety for crews in manned flights than the large single engine in the same time period. The use of a cluster requires larger production rates and thus greater reliability will be developed earlier. In addition, many development problems can not be foreseen for the large single engine because of the large jump in thrust level over present experience. Thus, the schedule of the large single engine is considered to be quite uncertain.

Another important consideration in designing this vehicle is economy. Because of the large payload capability, many possible missions can be envisioned. Some of these have already been described in Section II C. This variety of missions will require a large number of firings. To make a program of this size economically feasible, booster recovery must be used. The clustered engine approach is more suitable for booster recovery than the single engine approach. Should engine damage occur during the recovery operation, only the damaged engines or parts thereof must be replaced in the clustered arrangement rather than the one large and costly single engine.

C. Tankage Design

Several different tankage designs can be envisioned for a booster of this size. Four of the most promising are shown in Fig. 2.

The first configuration given consists of a single large tank, 216 in. in diameter, with an internal bulkhead to separate the LOX and RP-1. The main advantages of this method are minimum overall dimensions, minimum plumbing, no additional pressurization or vent manifold, and utilization of existing design experience since this is the conventional tankage approach. However in a booster of this size, conventional tankage has certain disadvantages. The handling of the tank would be complicated since it could not be broken down into smaller components. The only available means for transporting a 216-in. diameter cylinder cross country is by water. New tooling would have to be provided and production facilities at ABMA would have to be modified. The fuel feed lines would extend through the LOX container. In addition, an insulated bulkhead and heavier anti-slosh structure would be required.

~~SECRET~~

COMPARISON OF POSSIBLE JUNO V BOOSTER TANKAGE DESIGNS

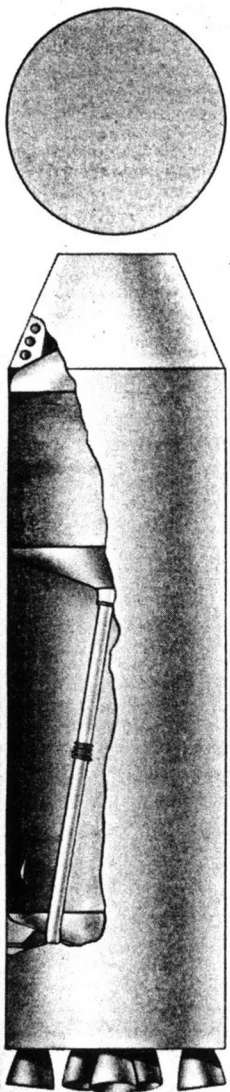

①

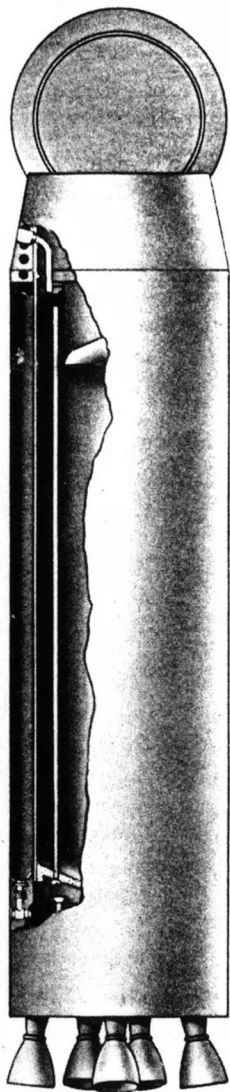

②



③

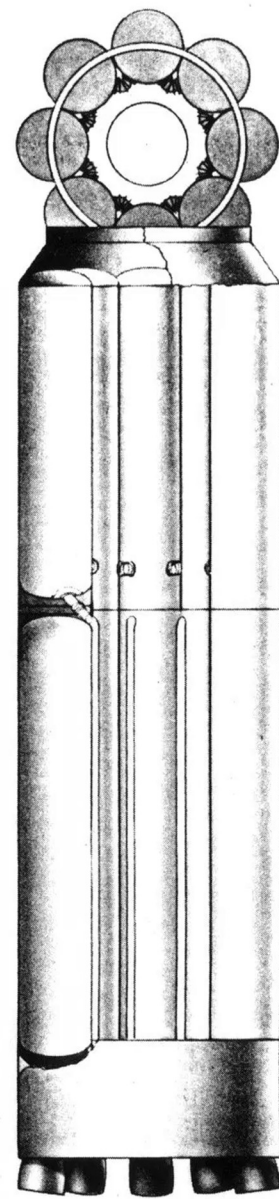

④

~~SECRET~~

The concentric tank arrangement (number 2, Fig. 2) consists of an inner LOX container and an outer fuel container. The outside diameter would be the same as the single tank. The major advantages of this design are the elimination of fuel lines running through the LOX tank and the reduction of the slosh problem. Due to such items as double cylindrical walls and insulation between LOX and fuel containers, the concentric tank design would be approximately 20% heavier than the conventional design (number 1, Fig. 2).

The third configuration given in Fig. 2 is comprised of nine tanks - a center tank of JUPITER diameter (105 in.) surrounded by eight tanks of REDSTONE diameter (70 in.). These diameters were chosen to take advantage of existing tooling and production facilities and to reduce initial cost. The outside diameter of the arrangement is 256 in. LOX is carried in the center tank and four of the outer tanks. Fuel is carried in the four remaining outer tanks. The advantages of this system include easier handling and transporting because the booster tankage can be disassembled and each tank handled and shipped separately. Since off-the-shelf hardware can be used, shorter fabrication time and lower manufacturing costs can be realized. Center bulkheads and fuel lines through the LOX tanks will not be required and the well-proven JUPITER anti-slosh design can be used. The disadvantages include larger outside diameter, more structural members required, and the need for additional pressurization and vent manifolds.

The fourth configuration shown in Fig. 2 consists of eight REDSTONE diameter tanks in a circular arrangement with an outside diameter of approximately 256 in. Each tank would contain both LOX and fuel and would require a center, insulated bulkhead. In this design longer tanks would be required; however, by omitting the center tank, sufficient space is gained to permit the placing of fuel lines in the center opening and thus eliminating the need of running them through the LOX containers.

After preliminary study, the multiple-tank arrangement of one center tank surrounded by eight outside tanks has been selected as the most advantageous design for the Phase I of the JUNO V program.

D. JUNO V Staging Considerations

In any new design the possibility of introducing various concepts exist. In the JUNO V vehicle development the possibility of using a different type of staging was investigated.

This principle, shown in Fig. 3, is called parallel staging and differs from the conventional staging, shown in Fig. 4, as follows. All of the

PARALLEL STAGING DESIGN FOR JUNO V

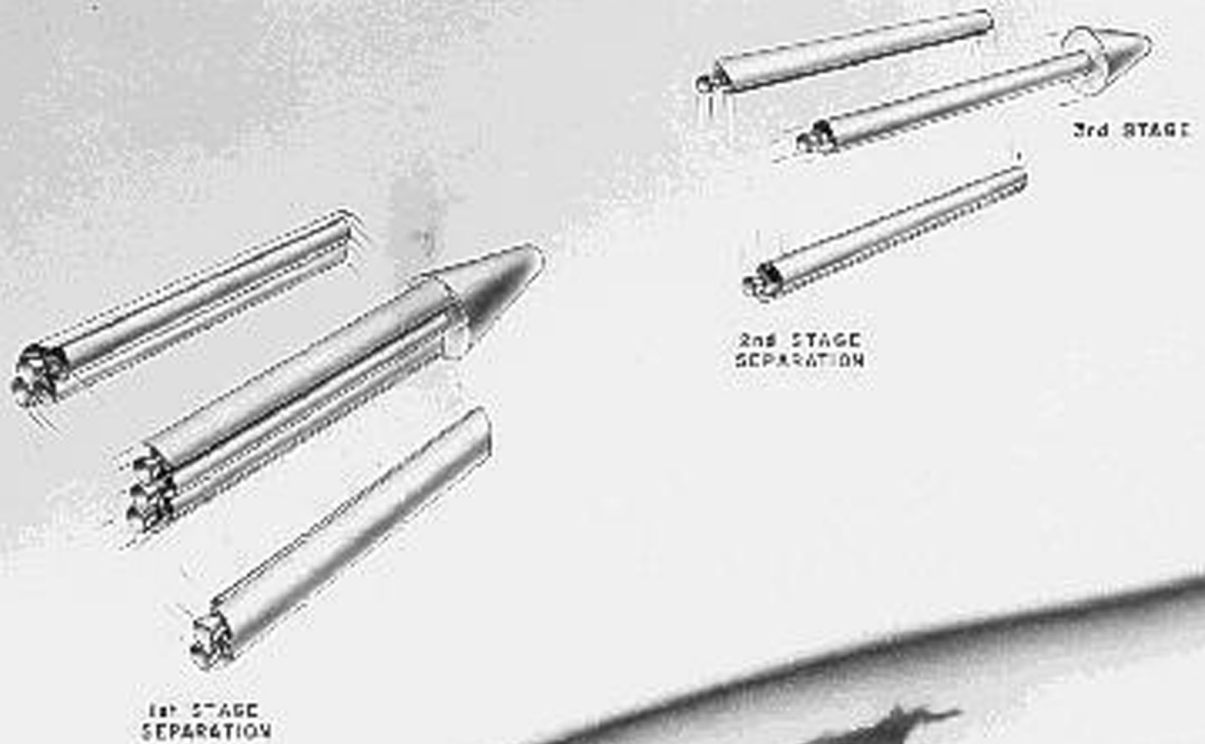
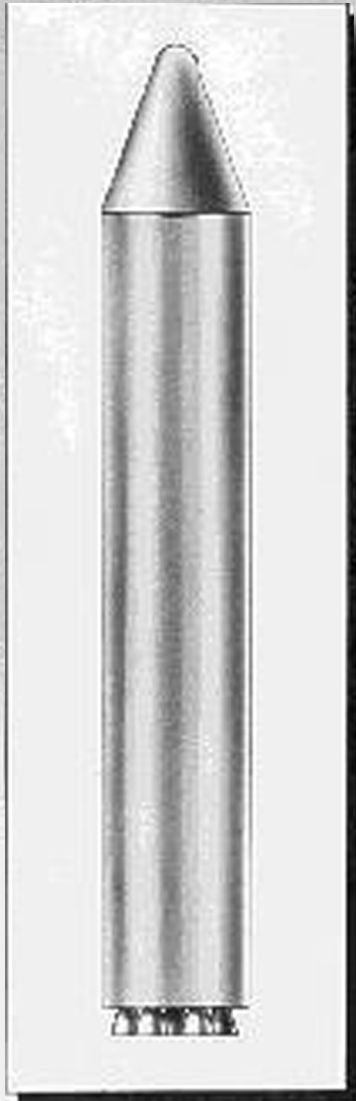
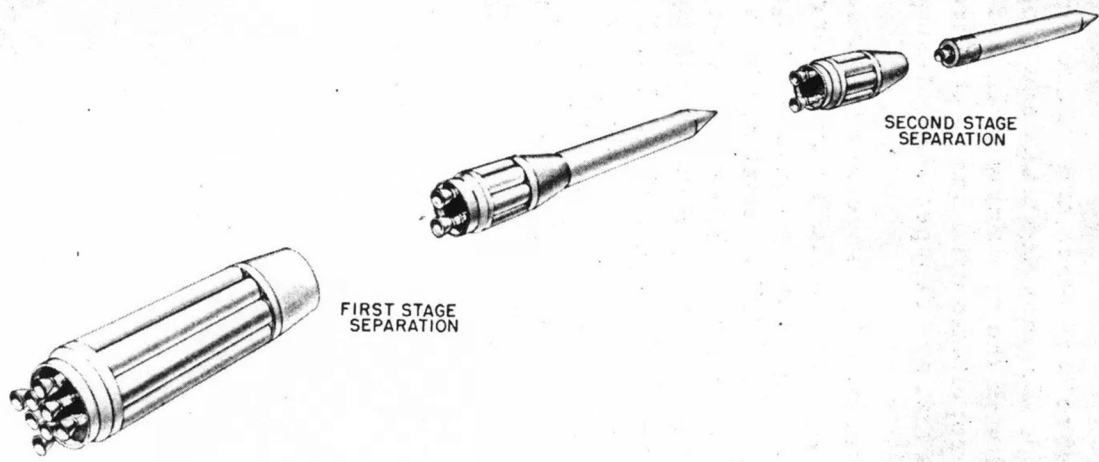
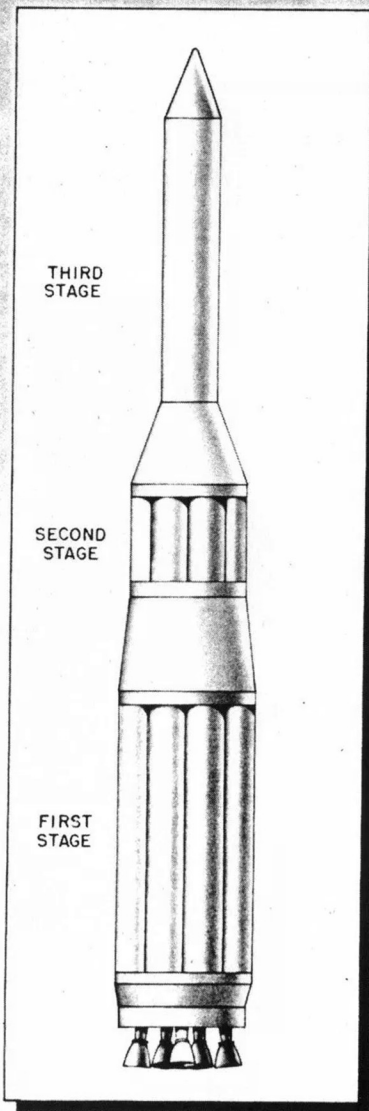

FIG. 3

~~SECRET~~



CONVENTIONAL STAGING DESIGN
FOR JUNO V

~~SECRET~~

FIG 4

F 10

vehicle engines are mounted parallel to each other and all are ignited and burn with full thrust from the ground. Engines and tanks are dropped off as the stage requirements are fulfilled with the remaining tanks and engines continuing as the next stage. The propellants used during the first-stage burning are supplied from the tanks that are dropped at first-stage separation.

The parallel staging arrangement has several advantages over the conventional staging. It allows for more flexibility in burning times for individual missions. It also eliminates the problem of altitude ignition which is inherent in the conventional staging. A smaller total number of engines is required to perform the same mission and the engines are better utilized since the center engines burn for a greater time. With all engines burning from launch, a shorter total burning time is required and thus less gravity losses are incurred. A smoother acceleration throughout powered flight is also achieved which may be more desirable for manned space flight. Parallel staging would result in a shorter, more compact vehicle and could reduce the assembly, launching, and handling problems.

Several disadvantages of the parallel staging over the conventional arrangement should be mentioned. Since some engines will burn throughout the powered flight of the vehicle, they cannot be used at their optimum expansion ratio. Also the last stage will be somewhat heavier because of the additional valves and thrust frame attached resulting in performance loss. A new technique satisfying all reliability requirements must be developed and tested which may result in a longer development time and higher cost. Separate feed systems will be required to provide maximum propellant utilization and modifications will be required for the use of high-energy or storable propellant in the upper stages. Due to the above-mentioned required developments, the parallel-staged vehicle would probably not be available as early as a conventional-staged vehicle; however, experience gained from the ATLAS program might be applicable.

Since the parallel staging principle would require additional manpower, funds and time, the first four boosters will be of conventional design with clustered tanks. Further studies will be made to determine the potentialities of the parallel staging concepts for the JUNO V program.

E. Guidance and Control

The JUNO V space vehicle booster will be controlled by the use of techniques and components similar to those employed on the JUPITER missile. However, the control system will impose some requirements on the overall design. Two basic requirements will be discussed and are shown in Fig. 5.

CANTING OF ENGINES

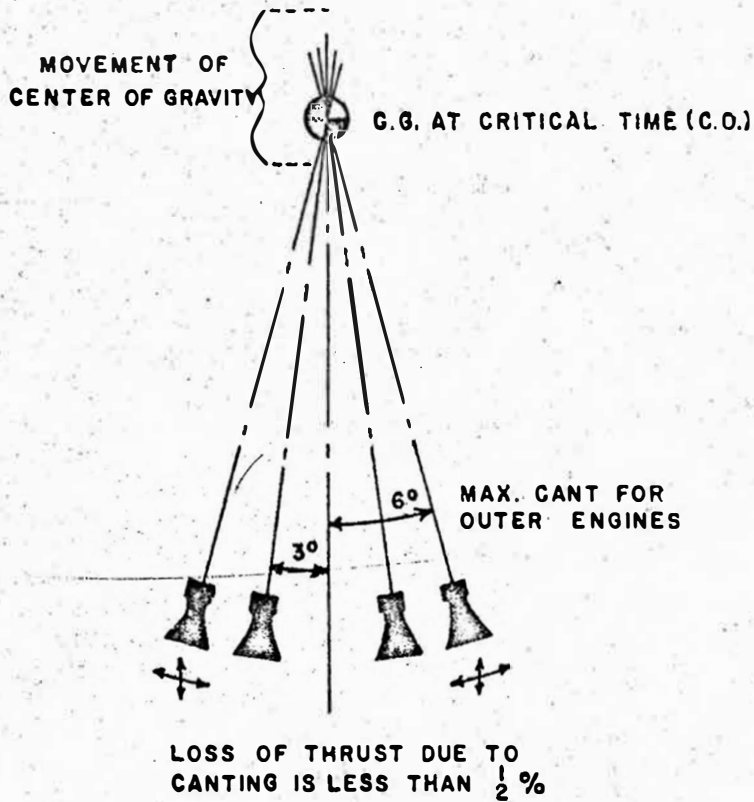

ENGINE CONFIGURATION

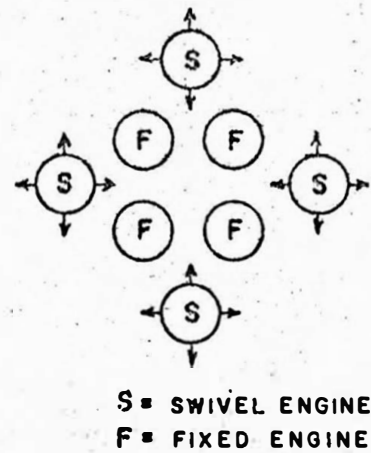

ENGINE THRUST DEVIATIONS

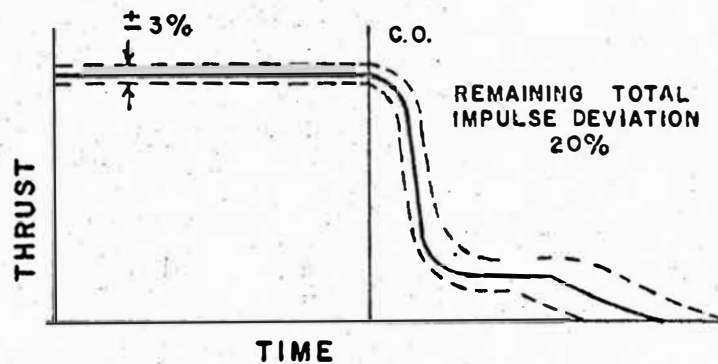

JUNO V GUIDANCE & CONTROL REQUIREMENTS

5-17

a. Canting of all the engines so that the thrust vectors pass through the center of gravity of the vehicle.

b. Swiveling of the four outer engines used for control.

Canting of all engines instead of a parallel arrangement is desirable from the control standpoint because the effects of thrust misalignment, thrust differences, differences in cutoff impulse, and failure of an engine will be minimized. With engines canted, these deficiencies will result in a parallel drift of the flight path but not rotation of the vehicle about its center of gravity. Compensations for such deficiencies can be effected by small corrective maneuvers. If parallel arrangement of the engines is chosen, the effects of the deficiencies listed above are greatly increased.

Swiveling instead of hinging the engine appears desirable. By hinging the engines, forces provided by deflection of only two engines are available for controlling the pitch or yaw axis. If one of them fails, the remaining engine must provide adequate control forces, and comparatively large engine deflections are anticipated.

By swiveling the four outer engines, each will contribute in the control of the pitch, yaw, and roll axes. Therefore, the required deflection per engine for each axis is reduced, and failure of one will not require severe angular deflections of the remaining engines. Preliminary study shows the possibility of operating with swivel angles comparable to those on the JUPITER missile (seven degrees).

By adoption of the scheme proposed above (canting of all engines and swiveling of the four outer engines), a maximum safety factor with respect to control will be realized since the vehicle can be kept in control under extremely adverse conditions.

F. Booster Recovery

In order to conduct the overall JUNO V operational space vehicle program within the economic limitations that must be imposed, booster recovery, rejuvenation, and reuse of hardware is considered mandatory. An economic feasibility study has been made to verify this point (Ref. 1). With recovery, the number of boosters required for a comprehensive flight test program can be reduced by approximately 50 per cent. During the operational life of the JUNO V vehicle an even larger percentage can be saved.

In addition to the monetary savings realized through recovery, valuable information can be gained from studies conducted on boosters which

~~SECRET~~



PARACHUTE RECOVERY OF JUNO V BOOSTER

~~SECRET~~

FIG. 6

The payload increases to be gained by using propellant such as LOX-H₂, F₂-N₂H₄, and F₂-H₂ warrant their immediate development for third stage application. Initially, these high-energy-propellant (HEP) stages will be used only in unmanned space probes and cargo vehicles. As reliability is demonstrated, the high-energy-propellant third stage could be used for manned missions. This approach provides a continuing increase in performance, yet maintains reliability in the critical manned mission area.

The joint requirements of reliability and economy suggest the utilization of a previously developed storable-propellant fourth stage for missions requiring orbital maneuvering or terminal trajectory corrections such as space probes and landing vehicles.

The upper stages under consideration demonstrate the design philosophy of reliability and economy achieved by maximum utilization of existing developments, and the basis for growth with the advancing state of the art, without sacrifice of reliability in critical missions.

Several months will be required for a systems study and detailed investigations before any recommendations with respect to the choice of the total vehicle configuration can be made.

H. Mobility and Flexibility

It is necessary to establish the required mobility for the JUNO V vehicle and design the system to meet these requirements. Since this vehicle will probably be the workhorse of space travel for the next 10 years, all possible applications of the system should be considered in establishing these requirements.

Battlefield-type mobility is not considered feasible or necessary. However, the necessary mobility to allow firing from several launching sites in various parts of the world should be achieved. Due to the limitation of launching facilities during the early part of the R&D program, the firings will probably be restricted to AMR. For operational deployment of the JUNO V vehicle, an equatorial launching site is very desirable, if not mandatory, for most space and orbital missions. The military use of the subject vehicle may require launching sites within the zone of the interior to provide adequate defense for the launching sites.

The mobility or transportability of this vehicle system should be based on present or planned transportation capability and not require the development of new systems. With the trend toward air transportation, the JUNO V vehicle should be designed so that the complete vehicle system

is air transportable to insure maximum mobility. This can only be achieved with a vehicle of this size by using a multiple-tank configuration, thus permitting disassembly into several sections which may be transported separately and reassembled at the launching site. Figure 7 illustrates the air transportability of a clustered-tank booster design broken into its components.

With the increasing cost of missile and space vehicle systems, it has become evident that unless a future vehicle has considerable mission flexibility it will not be economically feasible. Since this vehicle will be utilized as a basic transportation unit of the 1.5 million-lb thrust class for the next decade or longer, it should fulfill the transportation needs for all possible missions mentioned earlier in the report (Section II C).

Flexibility in terms of hardware must also be designed into the system. For example, all booster engines should be completely interchangeable. The booster should also be designed with a capability to accommodate varying upper-stage configurations such as a modified JUPITER, modified TITAN, modified ATLAS, or possibly newly developed upper stages, including the X-15 and DYNA-SOAR.

I. Crew Safety and Reliability

To insure complete success of any mission is impossible, but the insurance of a high degree of success of a manned venture into space is mandatory. This high probability of completion of mission can be accomplished only by consideration of all parameters involved. These parameters include mechanical factors and human characteristics. Not only must each component of the vehicle meet the desired reliability, but the overall reliability must equal the required figure. This imposes very high requirements upon the reliability of individual mechanical parts. There is no component which is less important than another if the success or the failure of the mission depends upon it. However, this does not imply that in each mission failure there will be subsequent loss of life. The present expected reliability of mechanical factors is 90%. In each of the 10% failures, the desired intact recovery of the crew is at least 90%. Therefore, a 99% factor can be applied to human conservation in space flight. The human characteristics will dictate certain vehicle characteristics, such as maximum accelerations, so that the two must be optimized.

One of the most important contributions to a reliable booster is the engine cluster arrangement and its control characteristics which keep the vehicle stable even if one engine is shut off.

Reliability of components can be increased, but generally only at a cost—cost in terms of money, time, and payload. These penalties must be accepted, for the prime consideration is success of the mission. Optimization will be accomplished, but not to the point where reliability is endangered.

J. Growth Potential

The JUNO V vehicle first stage, as well as the total vehicle, is designed for growth potential. The design approach, however, is to establish the required reliability first and improve performance later without losing reliability. This seems to be the only logical approach since this vehicle eventually will be used for personnel transportation, and crew safety aspects have first priority.

The propulsion system arrangement allows the replacement of the four inboard engines by one large (i. e., the 1000 to 1500K F-1) engine as shown in Fig. 8. This can be done with any larger engine with approximately the same dimensions. The use of the same propellants (LOX/RP-1) would be desirable but is not mandatory due to the parallel tankage arrangement.

The tanks provide a capacity up to 750,000 lb of useful propellants based on the density of a LOX/RP-1 mixture (2.3:1). This allows the use of a total of 650,000 lb of usable propellant for the single- and three-stage vehicles, which is near optimum for booster recovery, and the use of 750,000 lb of usable propellant for the two-stage vehicle. Basically, it will be very easy to enlarge the tank volume by lengthening the tanks. Since each tank will be filled with only one propellant component, and since the basic diameter of the booster is large enough, changes in propellant volume will present no problem.

This flexibility is highly desirable if the take-off thrust should be increased or if the effective take-off acceleration should be increased. The installation of a fixed 1.5 million-pound thrust single chamber (F-1) engine would raise the total thrust up to 2.3 million pounds with the assumption that the four control engines would be uprated to 200K at that time. This is very likely since it is expected that the F-1, or a similar engine, will not be available for flight testing before 1963 or 1964. A 2.3 million-pound thrust level would allow take-off weights up to 1.75 million pounds which, in turn, would allow propellant weights up to 1.2 million pounds in the first stage if desirable. Thus, this growth potential of the booster and, therefore, the entire vehicle is considered highly desirable.

The present approach of parallel tankage design, but conventional staging, allows the best possible flexibility with respect to upper staging.

~~SECRET~~

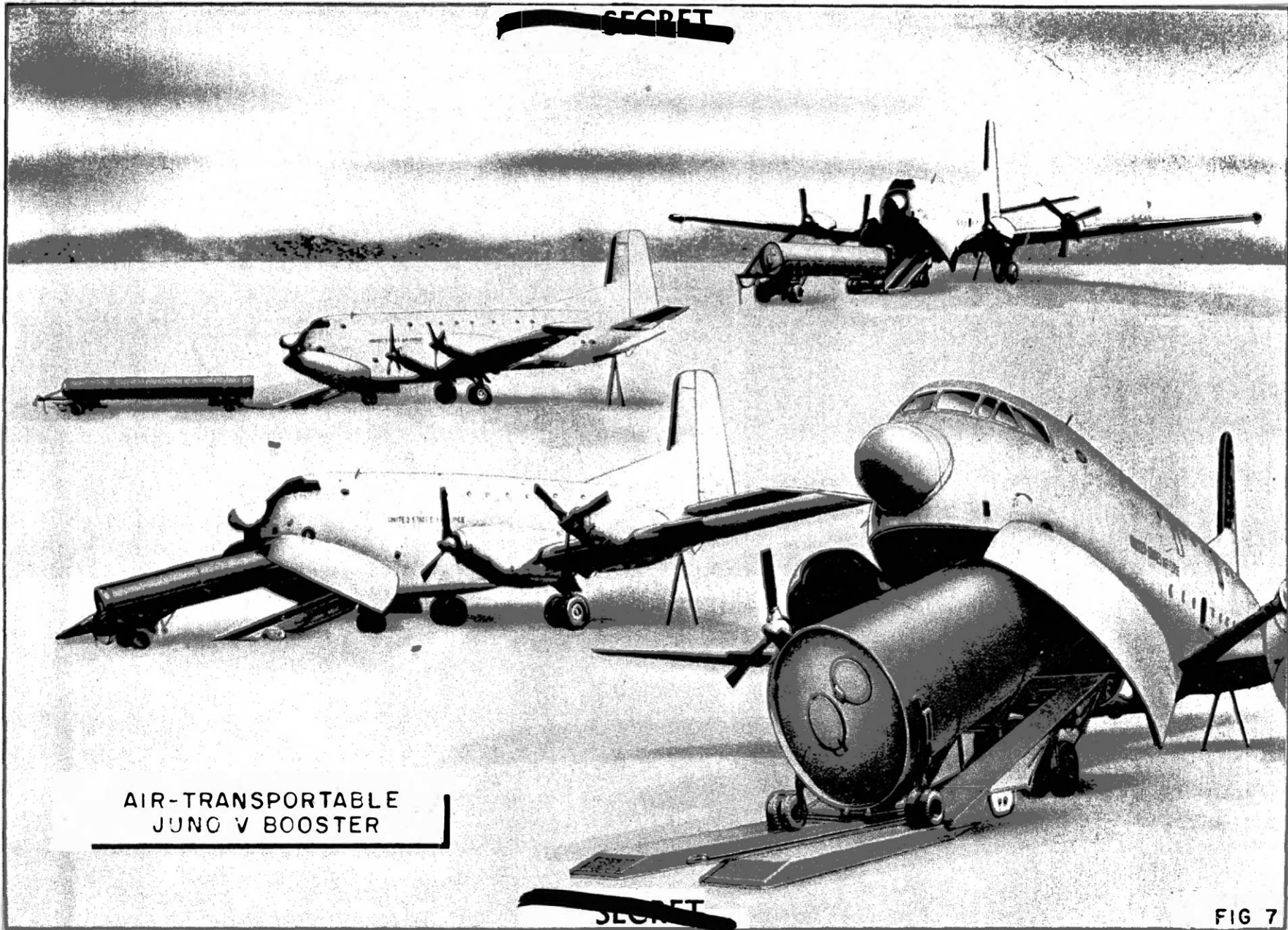

AIR-TRANSPORTABLE
JUNG V BOOSTER

~~SECRET~~

FIG 7

~~SECRET~~

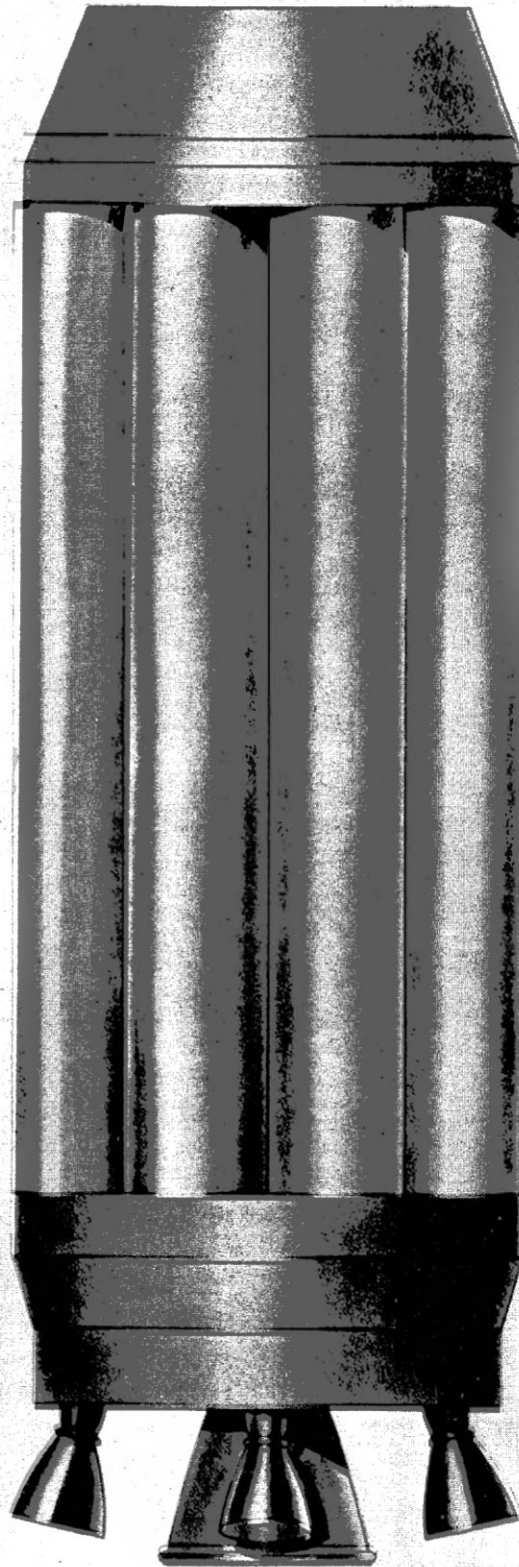

PROMISING GROWTH POTENTIAL
OF JUNO V BOOSTER

~~SECRET~~

FIG. 8

Initially it is expected to use upper stages with conventional propellants, such as LOX/RP-1, in connection with the most reliable hardware available. Later as improved engines with high-energy propellants become available (provided these have at least the same reliability) the upper stages can be changed. Thus, a large growth potential with respect to performance is available which can easily exceed payload capabilities of 50,000 lb at a 300-mile altitude for orbital missions.

K. Manufacturing Considerations

In designing the JUNO V booster stage, every effort should be expended to make the final design compatible with the ABMA Fabrication Laboratory facilities. The clustered-type tankage recommended in Section III C satisfies this objective.

Although any type of tankage could be fabricated in time to meet the required time schedule, clustered tankage will help to ease this schedule by decreasing the fabrication time required. The proposed tankage, by using REDSTONE (70 in.) and JUPITER (105 in.) diameters, will make use of present tooling and facilities, such as welding fixtures, head dies, hydrostatic test stand, X-ray facilities, and handling equipment. This method also makes use of the vast experience which has been built up by the fabrication and assembly personnel in producing REDSTONE AND JUPITER missiles.

Since the proposed design is made up of several identical parts, it lends itself to production line techniques where many major components can be processed at the same time using many crews. This method will help to reduce the fabrication and assembly time and will yield more reliable and less expensive boosters. A design based on a large single tank would impose working space restrictions which would not be compatible with large working crews, thus eliminating production-line methods and requiring longer fabrication and assembly time.

In case of mobilization, the production of the clustered-tank booster could be dispersed over a large area to prevent destruction of more than a limited number of major subassemblies or fully assembled boosters. The components could be shipped from the production plant to the launching site and assembled there for firing.

IV. DESCRIPTION OF JUNO V SPACE VEHICLE

A. Booster Configuration

The basic booster structure consists of eight 70-inch diameter tanks arranged around a central 105-inch diameter tank. The total diameter of the booster is 21-1/3 feet. (See Fig. 9.) The basis for this selection of tank arrangement has been discussed in Section III. The central tank and four of the outer tanks will contain LOX and form the load-carrying structure of the booster while the remaining four outer tanks will contain fuel. The design usable propellant capacity is 750,000 pounds. Due to thermal contraction in the LOX tanks, the 4 outer fuel tanks will not be used as basic structural elements, since they will have a gliding upper bearing to allow for LOX tank contraction. The engine-mounting structure transmits thrust and gimbaling loads into the center LOX tank structure, and partially into the outer LOX tanks which carry thrust loads and bending moments into the adapter structure for the upper stages. ABMA analysis confirms the findings of Reference 2 and indicates that there are no aerodynamic objections concerning the open tank arrangement; however, if some unforeseen problem should arise, a thin skin can be added around the tanks.

The basic single engine will be the NAA H-1 designed for 188K. This engine is a greatly simplified and repacked S-3D engine which is used in the JUPITER, THOR, and ATLAS missiles. All the components have been thoroughly developed and have extensive static test times accumulated. Some components have been extensively flight tested. All components have been static test fired at thrust levels exceeding 188K successfully. The simple pressure sequencing start system and the improved turbopump design were developed and extensively tested under the X-1 engine development supported by Air Force contracts. This modified S-3D engine, improved by a large number of static and flight tests within the ballistic missile programs, provides a thrust chamber and accessories that are truly reliable workhorse items.

The turbopumps are mounted on the thrust chambers in such a manner that each engine is an integral unit. The reliability and economy inherent in the utilization of thoroughly developed and tested components from other programs provide, within a short period of time, a reliable improved engine specifically adapted to clustering.

Eight of these modified S-3D engines will be incorporated into the booster cluster. They are arranged with four fixed engines mounted in the center with the remaining four mounted outside and gimballed for roll, pitch, and yaw control. This design will give sufficient control forces even if one engine should fail during powered flight. All engines are canted so that their

~~SECRET~~

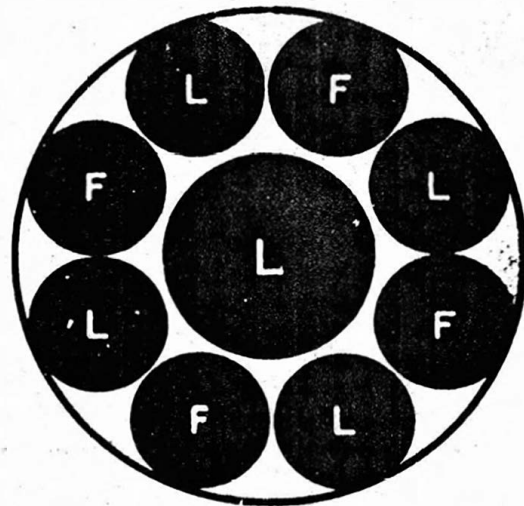
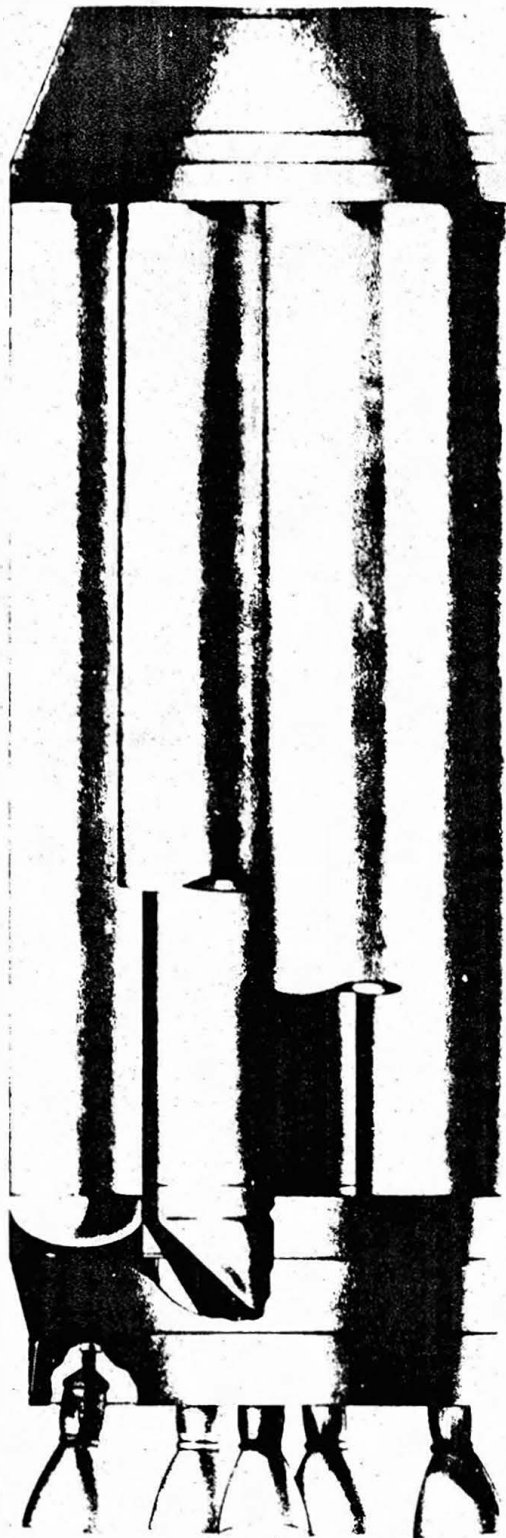

PROPELLANT TANK ARRAY

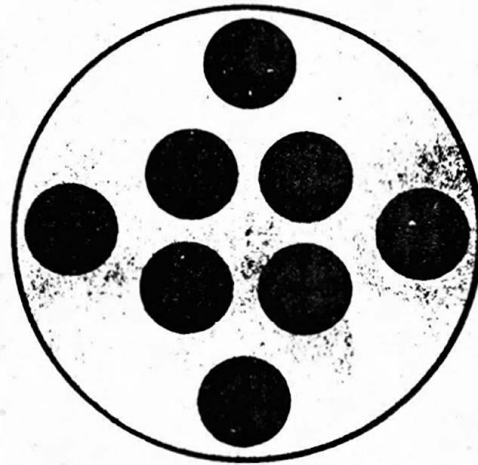

ENGINE ARRAY

JUNO V BOOSTER

~~SECRET~~

FIG. 9

lines of thrust pass through the critical vehicle center of gravity. The exact angles of cant will be determined during the final vehicle design.

For crew safety, individual fire walls and a fire extinguisher system will be provided for each engine so that in case of fire only the affected engine need be shut down and the remainder can continue to burn. Vents will also be provided to eliminate any accumulation of combustible gases in the tail section.

The new eight-engine propulsion system will have only 10 major components per engine as compared to the 68 components of the original S-3D engine. This is the major advantage of using the modified engine. Proven propellant-tank pressurization methods are being studied to determine the optimum methods with respect to simplicity and reliability. A simple nitrogen pressurization system will be used in the first four boosters.

The single booster, as well as the final booster for a multistage vehicle, is designed for recovery due to the valuable hardware involved. A recovery of the first two flyable boosters would also tend to accelerate the development schedules since any trouble which might develop could be thoroughly investigated after recovery. Moreover, some of the recovery hardware will be used for further testing resulting in considerable savings of money and hardware lead time.

The simplest recovery system available will be used in the early flight tests. This consists of six 100-foot diameter parachutes, attached to the top of the booster, which will be ejected at about 7000 ft altitude, after the booster speed has become subsonic due to its own aerodynamic drag. The parachute package, weighing approximately 1800 lb, will reduce the booster velocity to about 35 ft/sec.

This final velocity will be reduced to near zero by 12 brake rockets (FALCON solid-propellant motors or similar) each providing about 5000-lb thrust for 1.4 sec. These brake rockets will be ignited by a proximity fuze when approaching the water surface. The booster will be floated into an LSD and brought back to the Cape Canaveral harbor. It is hoped that the feasibility of recovery of big boosters can be demonstrated in this way. The optimization of the recovery system will be carried out in due course of development, as soon as the expected firing rates, and other specifications, for the entire transportation system have been determined.

B. Interim Two-Stage Test Vehicle

Several possible second-stage configurations appear desirable for the interim test vehicle. The basic requirement is for an economical and

reliable second stage that will orbit sizable, useful payloads early in the R&D phase of the big booster. Modified REDSTONE, JUPITER, or THOR missiles promise high reliability as upper stages. Modified ATLAS or TITAN vehicles will offer at this time substantially increased payloads, however, with somewhat lower reliability than the highly-developed single-stage missiles. The desired early schedule and the limitation of funds probably will determine which stages are most desirable. Figure 10 shows the two-stage configuration utilizing a JUPITER for the second stage. A detailed study of possible configurations is underway.

Two basic problems of the REDSTONE, JUPITER, and THOR will be altitude start of the engines and structural modifications required to take the first stage accelerations of 8 to 10 g's. The altitude start problem is roughly the same for all engines. Considerable experience has been gained in this problem by the TITAN second-stage program. Structural modifications to the single-stage missiles will be much less than that for the ATLAS or TITAN.

All two-stage configurations will not provide booster recovery since the required cutoff velocity is so high that the aerodynamic heating during re-entry would require considerable heat protection to the booster structure. Thus, the recovery of the first stage of a two-stage orbital vehicle (Numbers 3 and 4) does not look attractive at the present time.

The question as to which hardware should be chosen for the second stage of the two-stage interim test vehicle (with orbital capability) is presently being studied in detail. It is expected that a firm recommendation on this subject can be made within about four to eight weeks.

C. Promising Multistage Vehicle Configurations

The objective of the JUNO V vehicle development program is a flexible transportation system for a great number of space missions. Some of these missions require three- and four-stage vehicles, and all require emphasis on reliability, schedule, and performance.

Therefore, it seems advisable to study the question of upper stages in great detail, from the systems point of view, in order to satisfy all requirements in an economical way at the earliest possible date.

Some of the most promising multistage vehicles to be studied further are shown in Fig. 11 and listed below:

~~SECRET~~

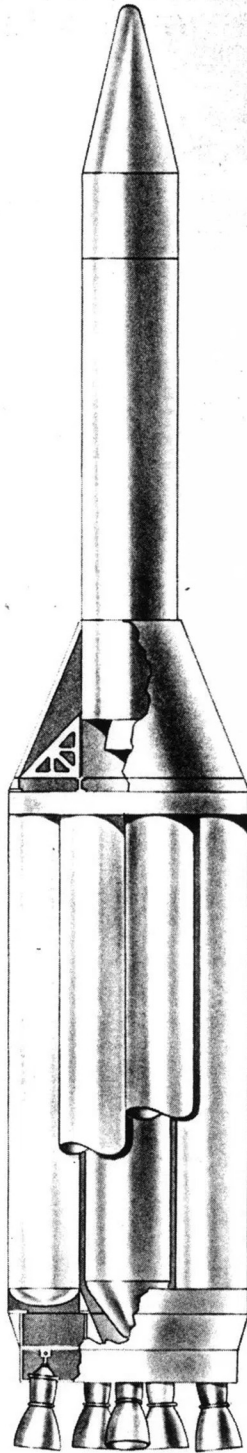

JUNO V TWO - STAGE FLIGHT TEST VEHICLE

~~SECRET~~

FIG. 10

~~SECRET~~

PROMISING JUNO V THREE-STAGE CONFIGURATION WITH 30,000 LB PAYLOAD

PAYLOAD SPECIFIC GRAVITY = 0.2

PAYLOAD SPECIFIC GRAVITY = 1.0

PAYLOAD SPECIFIC GRAVITY = 0.2

PAYLOAD SPECIFIC GRAVITY = 1.0

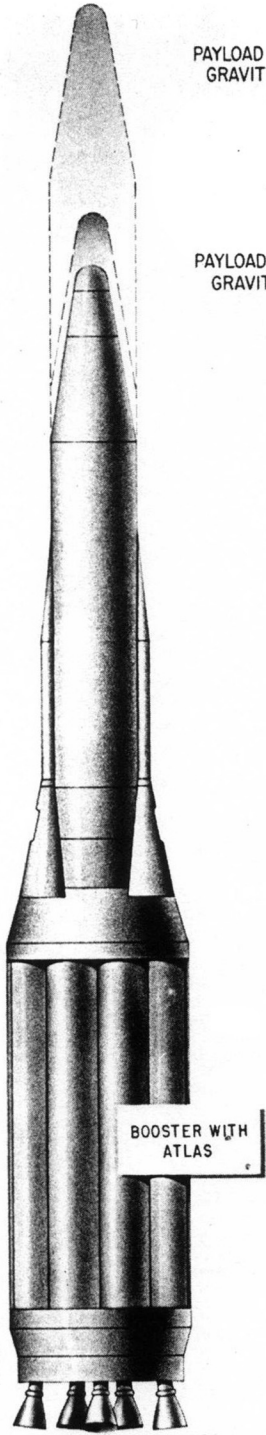
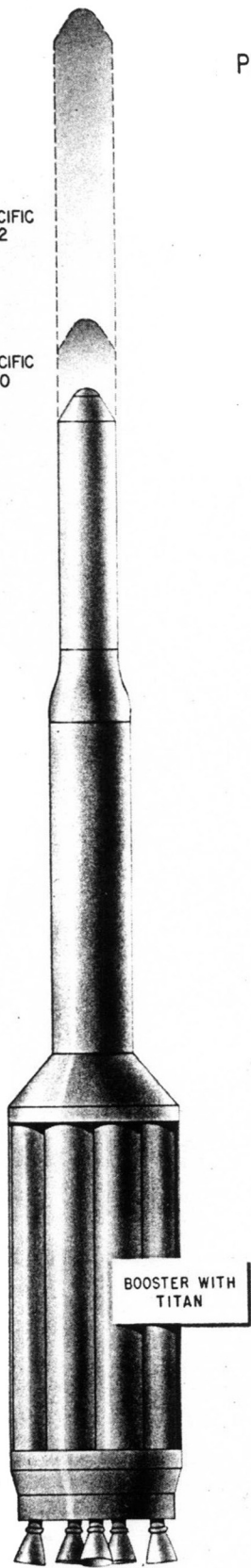

FIG. 11

~~SECRET~~

1. Conventional Staging with Conventional Propellants

- a. First stage: Booster with eight engine clusters (LOX/RP-1)
 Second stage: Modified TITAN first stage (LOX/RP-1)
 Third stage: Modified TITAN second stage (LOX/RP-1)

This vehicle configuration is considered as typical for a conservative approach and was used for performance calculations and determination of payload capabilities.

- b. First stage: Booster as above
 Second and third stages: Modified ATLAS vehicle (LOX/RP-1)
- c. First stage: Booster as above
 Second stage: Optimized new second stage of about 216-in. diameter (LOX/RP-1)
 Third stage: Modified JUPITER (LOX/RP-1)

2. Conventional Staging with High-Energy Propellant Upper Stages

- a. First stage: Booster as above
 Second stage: Modified TITAN first stage
 Third stage: 75K fluorine/hydrazine engine (NAA)
- b. First stage: Booster as above
 Second stage: Optimized 216-in. diameter, 410K thrust (LOX/RP-1)
 Third stage: Optimized 50 to 100K (H₂/O₂) stage (P&W)
- c. Four-stage configurations for space missions as (1-a), (1-b), (1-c), (2-a), or (2-b) with either the 6K JPL storable-propellant engine for lunar landing or planetary satellite missions, or the 12K NOMAD (LF₂/N₂H₄) engine for a high-energy space probe.

3. Parallel Staging

- a. Seven LOX/RP-1 (NAA-1 88K) engines used for all 3 stages as shown in Fig. 3.
- b. The parallel staging vehicle utilizing high-energy propellants would consist of:

First stage: 7 LOX/RP-1 (same as 3a)
 Second stage: 3 LOX/RP-1 (same as 3a)
 Third stage: 1 H₂/O₂ or N₂H₄/N₂O₄

4. Conventional Staging with Nuclear Propulsion System in Second Stage

- a. First stage: Chemical booster (as in C 1 and 2)
- Second stage: Nuclear propulsion system using H_2 as follow-on of ROVER project
- Third stage: Chemical high-energy or storable-propellant engine for midcourse correction or terminal maneuvers on space missions.

All of these as well as other configurations are being studied at the present time by ABMA, and preliminary results from these investigations will be available by the summer of 1959.

V. PHYSICAL CHARACTERISTICS AND PERFORMANCE

A. Weight Breakdown

Table 1 presents the weight breakdown upon which the performance calculations for the various configurations were based. These weights are nominal values for a typical case and will vary for any specific mission. The interim two-stage flight test vehicle and the typical three-stage vehicle uses LOX/RP-1 propellants. The upper limit of the three-stage vehicle performance band is based on these weights but assumes a specific impulse of 365 sec vacuum (F₂/N₂H₄ propellants).

B. Preliminary Performance

1. Assumptions

The performance or payload capability was calculated for the JUNO V LOX/RP 1 booster with various possible upper-stage configurations. The assumptions which were made for these calculations are summarized as follows.

The vehicle was vertically launched and followed the path of a preset mathematical tilt function for the first 40 sec of the powered flight. After the first 40 sec of burning time, the missile followed a gravity-tilt zero-lift trajectory until the desired injection altitude was attained at a flight path angle of 90° with the local vertical. The vehicle then followed the path of a circular orbit until the velocity required for the desired mission was reached. Some control forces would be required to maintain this circular flight path; however, these forces are small and can be neglected for purposes of preliminary design.

The influence of the Earth's rotation was considered with the assumption that the vehicle was launched from an equatorial site in a due east direction. This assumption provides maximum benefit to the vehicle performance from the Earth's rotational velocity.

For the purpose of determining the performance of the booster, it was desirable to assume a complete vehicle including some type of upper staging. Many assumptions are possible for the considered upper stages, but, for simplicity, only a few configurations were considered for performance calculations. The performance of the eight-engine cluster booster was investigated as a two-stage satellite vehicle consisting of the JUNO V LOX/RP-1 booster with a modified JUPITER missile as the upper stage and a three-stage satellite vehicle, consisting of the same booster with a modified TITAN missile, as the upper stages.

Table I
JUNO V PERFORMANCE AND WEIGHT INFORMATION

Parameters	First Booster	Interim Flight Vehicle		Typical Orbital Carrier		
	Test Vehicle	Stage I	Stage II	Stage I	Stage II	Stage III
W _{11, 14, 15}	Net Payload, lb	250,000	119,450	11,400		25,000
W ₁₆	Instrumentation Compartment, lb	600		600		600
W ₁	Total Payload, lb	250,600	119,450	12,000	305,200	114,300
W ₂	Instrumentation (G&C), lb	800		800		800
W ₃	Fuselage, lb	27,450	27,450	3,550	24,900	4,209
W ₄	Propulsion, lb	16,450	16,450	2,500	15,900	3,700
W ₅	Recovery Equipment, lb	3,200	0	0	2,900	0
W ₆	Trapped Propellants, lb	4,800	4,800	600	4,800	1,200
W ₇	Useful Propellant Reserves, lb	18,900	7,500	2,000	6,500	1,800
W ₈	Expected Propellant Consumption, lb	650,000	750,000	98,000	650,000	180,000
W _u	Effective Net Weight, lb	71,600	56,200	9,450	55,000	10,900
W _c	Expected Cutoff Weight, lb	322,200	175,650	21,450	360,200	125,200
W _o	Expected Takeoff Weight, lb	972,200	925,650	119,450	1,010,200	305,200
r	Mass Ratio	3.0174	5.2698	5.5687	2.8045	2.4377
F _o	Takeoff Thrust, lb	1,200,000	1,320,000		1,504,000	
F _{vac}	Vacuum Thrust, lb			180,000		410,000
I _{spo}	Specific Impulse, sec	250	253		258	
I _{spvac}	Vacuum Specific Impulse, sec	284		285		310
Δ _t	Burning Time, sec	135.4	143.7	155.2	111.5	136.1
$\frac{W_8}{W_o}$	Fuel Ratio (effective)	0.901	0.930	0.912	0.922	0.943

34
SECRET

SECRET

Due to the large number of variables involved and the complexity of the differential equations of the vehicle's motion, it was necessary to calculate the trajectory data by numerical methods of integration.

Aerodynamic drag was considered in the trajectory calculations. An accurate drag coefficient curve was not available for the various configurations investigated; however, since the liftoff accelerations were reasonably low, the influence of drag during the powered ascent trajectory was relatively small compared to the other variable terms of the trajectory, such as velocity gain due to thrust increase with altitude, gravity loss, etc. To estimate the velocity loss due to drag, a drag coefficient similar to that of the JUPITER missile was assumed.

The performance investigations were based on the weight data given in Table 1, and the dimensions as shown on the sketches of the vehicle configurations in Figs. 10 and 11.

2. Payload Capability

The payload capabilities of the JUNO V space flight vehicle family are very impressive as compared to the satellite potential thus far demonstrated in this and other countries. The performance investigations reveal net payload capabilities up to approximately 40,900 lb in a 100-statute-mile circular orbit. Approximately 11,800 lb net can be injected into outer space with escape velocity for possible maneuvers in the vicinity of the Moon or some planet.

The gross payload capabilities of the booster, with the various upper stage configurations, are shown versus orbital altitude in Fig. 12. The gross payload is defined as the sum of the weights of the net payload (including payload container), instrument compartment, and the guidance and control instrumentation. The weights of these components are given in Table 1.

a. The Two-Stage Configuration

One of the earlier test missions of the JUNO V orbital vehicle will be that of a two-stage configuration. Restart capability will not be available in the JUPITER second stage; therefore, the payload must be brought into its orbit by a direct ascent method. Performance was calculated for direct ascension into a circular orbit, and the payload versus orbital altitude is given in Fig. 12. The maximum gross orbital payload of 20,000 lb is shown at an altitude of 160 km or 100 statute miles. Some increase in payload could be attained at lower orbital altitudes; however, this would be at the expense of a more circular aerodynamic heating problem. The maximum orbital altitude which can be attained with the two-stage version

JUNO II PAYLOAD CAPABILITIES VERSUS ALTITUDE

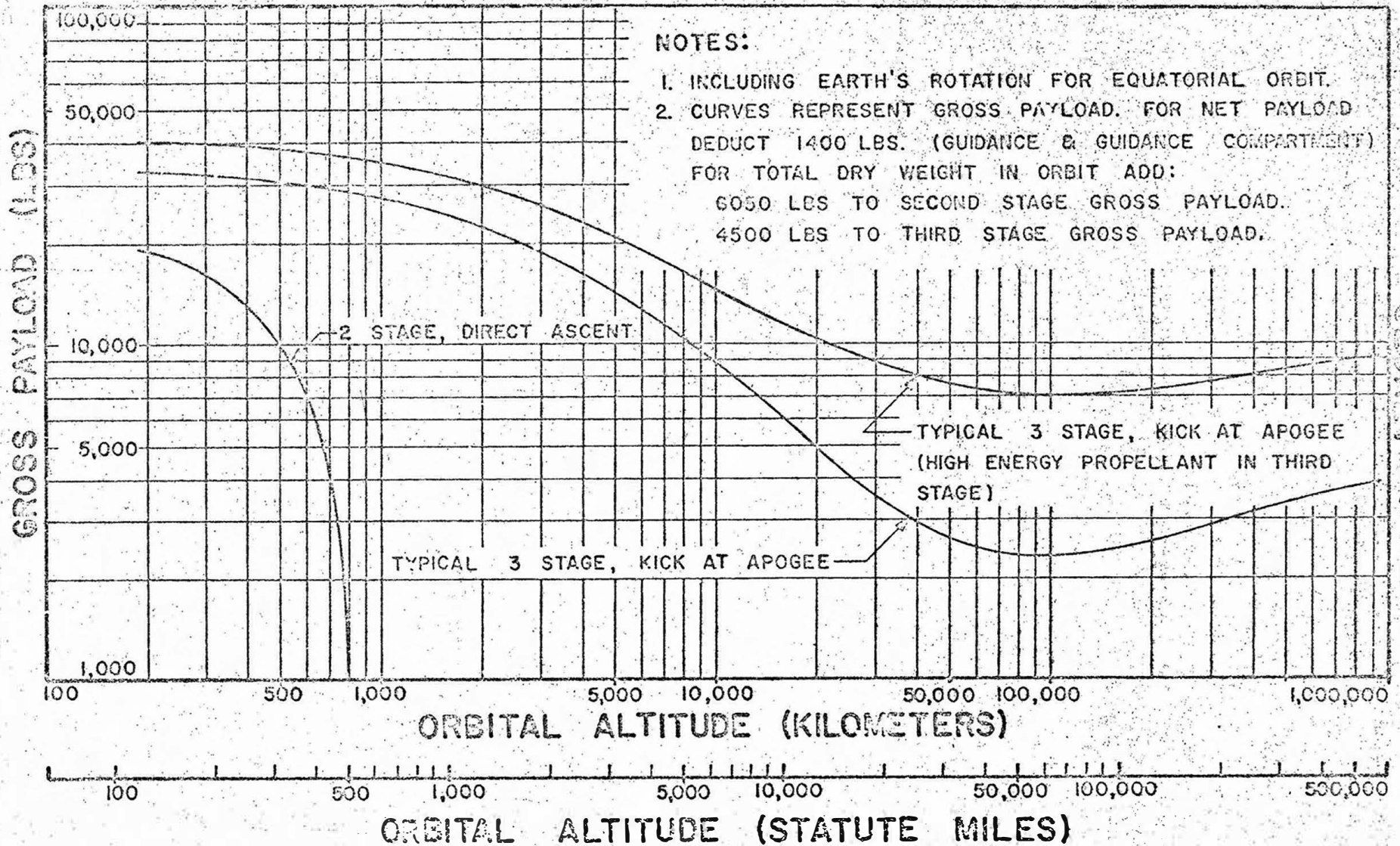

FIG. 12

without restart capability is approximately 750 km (470 statute miles), without a payload, however.

It was stated in the assumptions that these payload weights are based on equatorial orbits and a direction of due east. The larger the vehicle, the greater was the gain in payload due the rotational velocity of the Earth; therefore, for a polar orbit, the payload capability of this configuration would be considerably reduced. Assuming an azimuth of 13° retrograde for a polar orbit (near equatorial launch site), a velocity loss of approximately 560 meters per second results; this is equivalent to a payload penalty of approximately 5200 lb for the 100-mile orbit.

To allow for unpredictable variations in the trajectory, a surplus amount of propellant must be carried to compensate for any deficiency in the final cutoff conditions required to accomplish a specific mission. This surplus propellant is referred to as propellant residuals for flight performance reserve and is usually carried in the last powered stage. For the purposes of this investigation, propellant reserves consistent with the weight data in Table I were used. However, a flight performance reserve of 3 per cent of the final velocity requirement is recommended for an actual mission. For the two-stage vehicle, this 3% is equivalent to approximately 2300 pounds of propellant for the 100-mile orbit and 1550 lb for a 500-mile orbit; however, a total nominal propellant reserve of 2000 lb was assumed for the performance data given in Fig. 12. In addition to the 2300 lb or 1550 lb required for flight performance reserve, an additional propellant reserve must be included for variation of the mixture ratio which is relatively independent of the payload or altitude.

b. The Three-Stage Configurations

For the JUNO V carrier as a three-stage vehicle, it was assumed that the last powered stage will have either restart capability or a small fourth stage to provide a kick at the apogee of the transfer ellipse. The transfer ellipse method of ascending into the orbit is necessary for high altitudes and is the most efficient method payloadwise for lower altitude orbits.

Two performance curves for the three-stage configuration are presented in Fig. 12: one for the modified TITAN as the upper stages with conventional LOX/RP-1 propellants, and the other for the modified first-stage TITAN as the second stage with high-energy propellants in the last stage. The payload improvement to be derived from using the high-energy propellants is approximately 8000 lb for the 100-mile (160 km) orbit and 5650 lb for escape missions.

The maximum gross payload for a 100-mile circular orbit is approximately 32,900 lb with conventional propellants, and 40,900 lb with high-energy propellants, in the last stage. In computing payload capability at the high orbital altitudes, a minimum payload condition was found to exist for an orbit at a radial distance from the Earth's center of 15.58 times the radius vector or radial distance from the Earth's center to the point of injection into the transfer ellipse. The analytical proof that this minimum payload occurs at this altitude or radius vector is given in Reference 3. After the minimum payload is reached, the payload weight increases and approaches the escape payload as a limit as the orbital altitude is increased, without limit. The escape gross payload is 6150 lb with conventional propellants and 11,800 lb with high-energy propellants. The minimum gross payload in orbit is 1360 lb with conventional propellants and 7200 lb with high-energy propellants.

For a 100-statute mile (160 km) retrograde polar orbit, the velocity loss was approximately 560 meters per second (near equatorial launch site), and the resulting loss in payload was found to be 6900 lb with conventional propellants and 7100 lb with high-energy propellants in the last stage. For the orbital altitude, where the payload is a minimum, this velocity loss corresponds to payload penalties of 1700 lb with conventional propellants and 2200 lb with high-energy propellants. The total nominal propellant reserve of 3100 lb in the last powered stage was actually assumed for the purpose of performance calculations and the data given in Fig. 12. The surplus propellant normally required for 3 per cent of total characteristic velocity of the vehicle as a performance reserve is approximately 3050 lb for the 100-mile circular orbit and approximately 1500 to 1700 pounds for the escape condition. The lower propellant reserve for the escape mission results from the lower escape payload or lower cutoff weight of the final stage.

C. Volume Considerations

Because of the large payload carrying capabilities of the JUNO V family of space vehicles, it is necessary to consider the volume requirements for the payloads.

A study of payload compartment length, for payloads up to 40,000 lb, is shown in Fig. 13 for various payload densities. Three standard payload configurations were considered: 95-in. diameter (TITAN), 105-in. diameter (JUPITER), and 121-in. diameter (ATLAS). Payload specific gravity values of 1.0 and 0.2 were used. The specific gravity value of 1.0 would be for high-density cargo type payloads; the 0.2 would more nearly represent the value for instrumented manned or unmanned satellites or probes.

The consideration of volume requirements is of prime concern since it will dictate to a great degree the design of the ground-handling equipment, the control system of the vehicle, and the number of vehicle configurations which will be required.

As can be seen from Figs. 11 and 13, the use of conventional payload designs for the small-diameter upper stages, with payload weights of over 20,000 pounds and specific gravity of 0.2, will add excessively to the overall length of the vehicle. Therefore, in these cases, consideration should be given to other approaches, such as a "doughnut" design where the payload is wrapped around the last stage, or some other unconventional design.

D. Space Missions

The several different configurations of the JUNO V all-purpose vehicle described in Section IV, allow the user a wide variety of missions. These missions, described in Section II, may be grouped into four categories, namely:

- (1) Ballistic vehicle missions
- (2) Earth Satellite missions
- (3) Probes
- (4) Lunar and planetary missions

The ballistic vehicle missions, surface-to-surface transportation can be accomplished with the first stage booster only or the first stage booster plus a second stage. For preliminary performance calculations, a modified JUPITER propulsion system has been assumed as a second stage for the ballistic transport vehicle. The payload-range capability of the single-stage transport vehicle varies from 500,000 lb at 350 km (218 miles) to 20,000 lb at 3800 km (2360 miles), as shown in Fig. 14A. The payload range capability of the two stage transport vehicle varies from 100,000 lb at 2500 km (1550 miles) to 30,000 lb at 7500 km (4650 miles).

The JUNO V vehicle will have the capability of performing a large number of earth satellite missions. This capability has been previously described in paragraph V B. However, it should be noted that the two-stage version also places into orbit the empty JUPITER second stage of about 9000 pounds, most of which can be used for building material for a permanent satellite station, if desirable.

JUNO V PAYLOAD VOLUME REQUIREMENTS

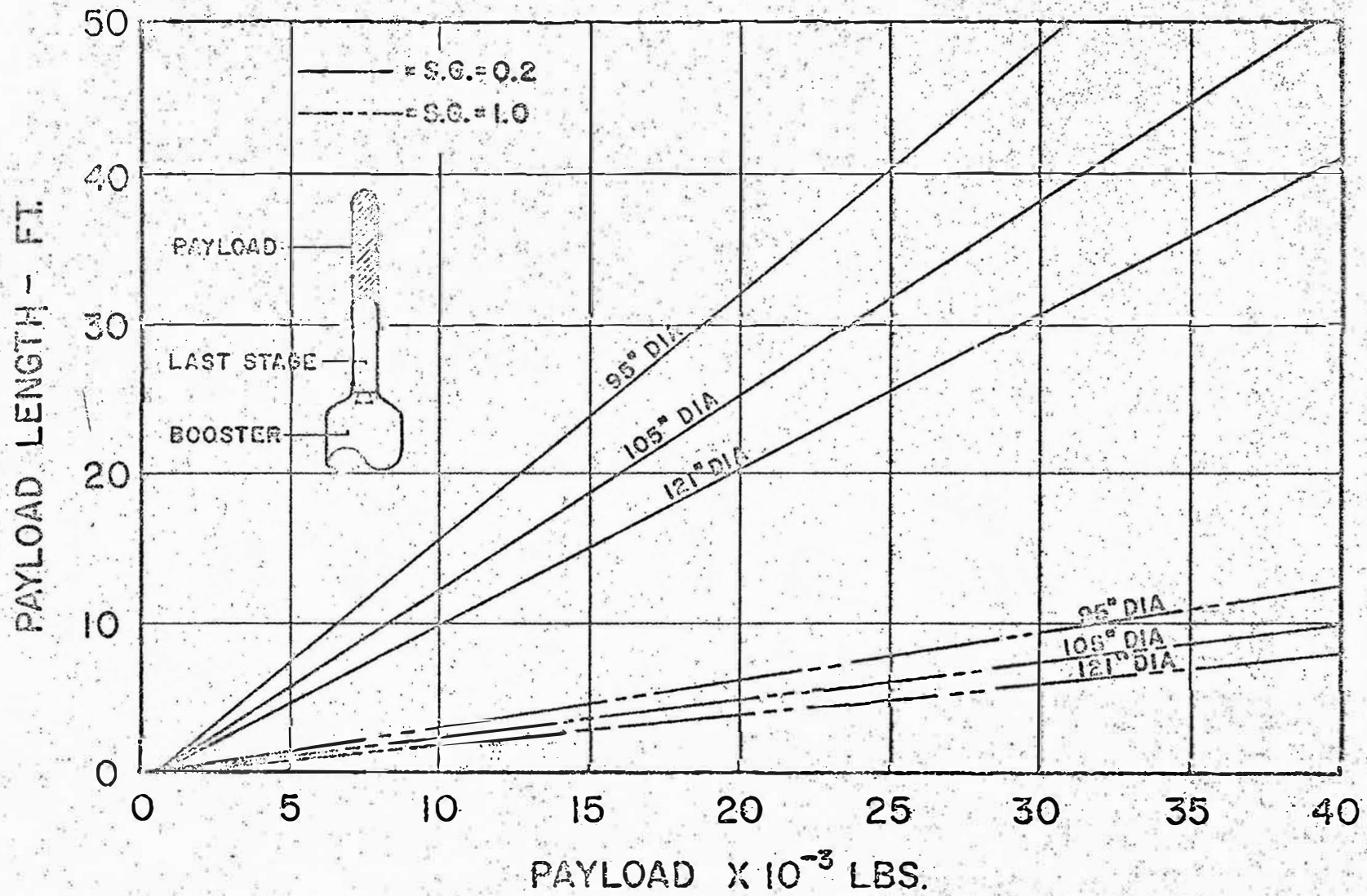

SECRET

FIG. 13

JUNO V PAYLOAD-MISSION CAPABILITIES— BALLISTIC TRANSPORT

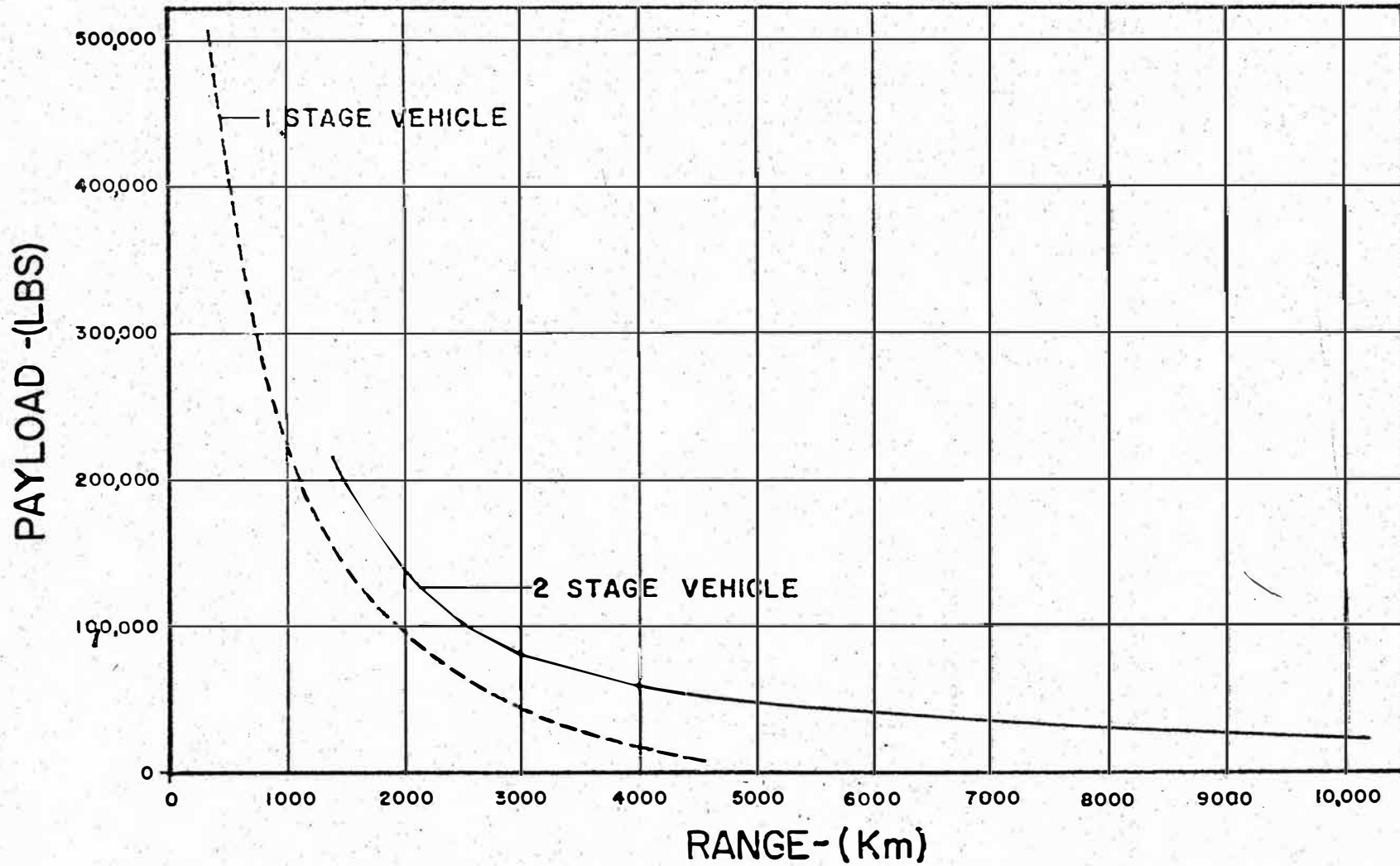

41
~~SECRET~~
FIG. 14(A)

~~SECRET~~



The 24-hour orbit, which is particularly desirable for communications and navigation satellites, can easily be attained with either of the typical three-stage vehicles shown in Fig. 11, with a payload of approximately 3200 pounds. The system utilizing a high-energy propellant third stage has a payload capability of 8200 pounds in a 24-hour orbit.

Figure 14B gives the payload capability for various types of special JUNO V missions ranging from orbital missions to outer space probes.

Since escape velocity is less than that required for the twenty-four hour orbit, the payloads for the LOX/RP-1 and high-energy upper stage three-stage JUNO V space vehicles are 6150 pounds and 11,800 pounds of gross payload, respectively.

Interplanetary missions having soft landing requirements may be accomplished if aerodynamic braking is employed. Payloads up to 4700 pounds, including weight required for soft landing system, may be placed on Mars or Venus.

Lunar soft landing, since no aerodynamic braking is possible, requires a fourth-stage braking rocket. A net payload capability of 3500 pounds can be obtained with a four-stage version of the JUNO V vehicle.

The capability exists for boosting the orbital X-15 with the two-stage vehicle. If the X-15 is loaded to a gross weight of 25,000 pounds, a velocity increment will be realized which will allow the orbiting of a manned vehicle.

JUNO V PAYLOAD-MISSION CAPABILITIES (SPACE MISSIONS)

MISSIONS

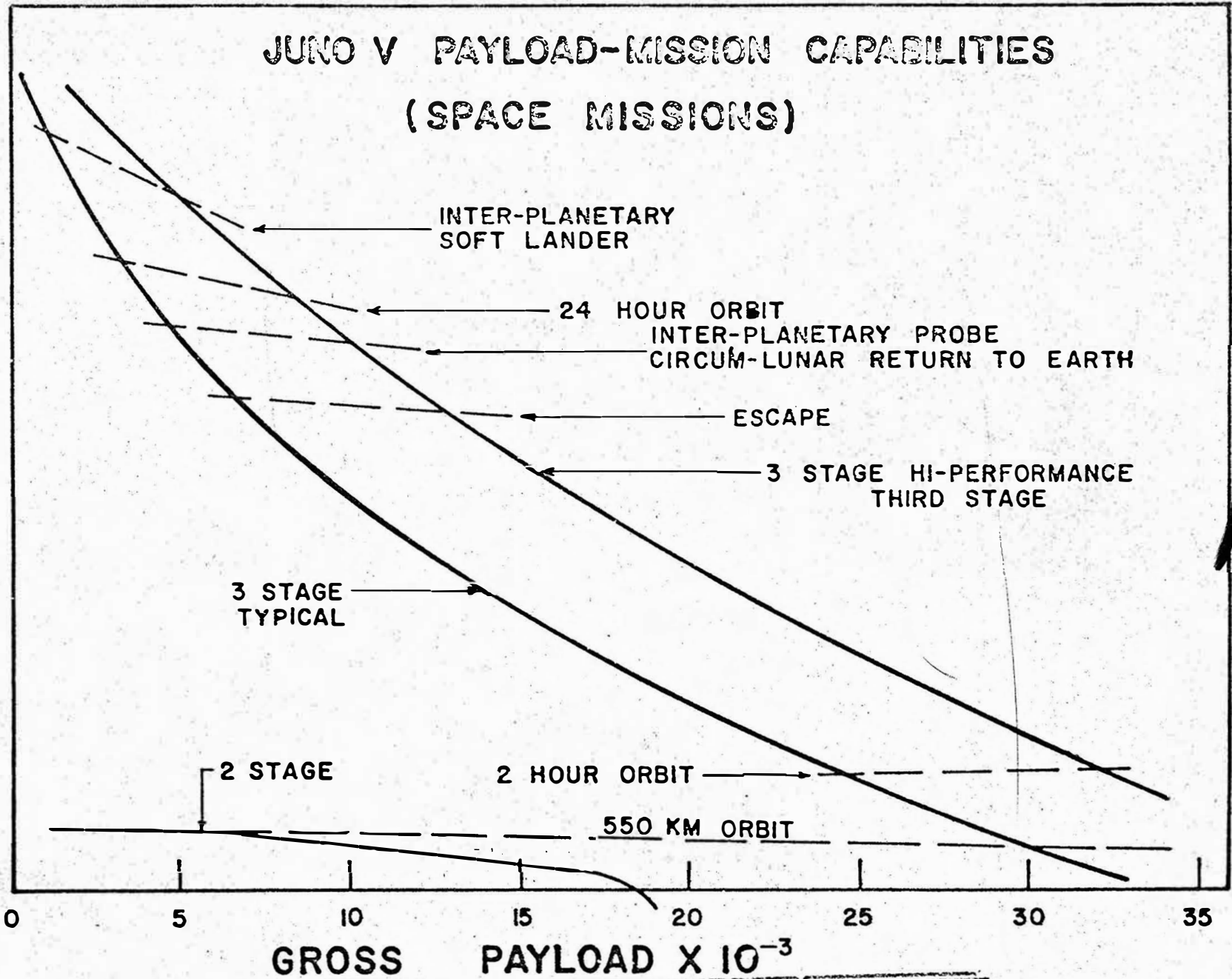

FIG. 14(B)

~~SECRET~~
43

~~SECRET~~

VI. OPERATIONAL CONSIDERATIONS

A. Test Stand Operations

The test stand operations required to support the JUNO V development program are based on the following objectives:

1. To provide or confirm performance data of components, sub-system, and complete booster system to the groups responsible for design, fabrication, and inspection.
2. To evaluate, by functional or simulated test, the hardware generated by the design decisions as soon as possible after the component, sub-system, or system is fabricated.
3. To establish, by study and complementary test programs, operational techniques, test facilities, test and support equipment, instrumentation, and organizational capability to execute the test program.
4. To accumulate technical confidence in the basic vehicle through the media of captive testing, and to apply this experience in establishing the operational capability and application of the subject booster.

These objectives form the basis of a test program predicated on accomplishing two goals. The first of these is to provide test data to resolve the problems involved in clustering a number of individually proven power plants into a booster system and to qualify the cluster for flight tests. The second goal is to refine the operational performance and reliability of the clustered booster to the point of establishing complete confidence in, and maximum return from, the flight test program.

It will be necessary to provide test stand positions, instrumentation, systems control networks, test and handling equipment, ground equipment, operational techniques and checkout and operating procedures. The largest single item will be the modification to the east position of the present static test stand. The modified stand with the JUNO V booster stage installed is shown in Fig. 15.

Water flow evaluation tests on the propellant supply manifolds will be accomplished as soon as possible and before the entire tankage has been fabricated. These early tests will afford a preliminary evaluation of the manifold and help in providing information for the development of the instrumentation for the complex flow system. Water flow tests on the complete booster tankage and manifold system can be conducted before the engine hardware is available. This approach again will provide the dual advantage

~~SECRET~~

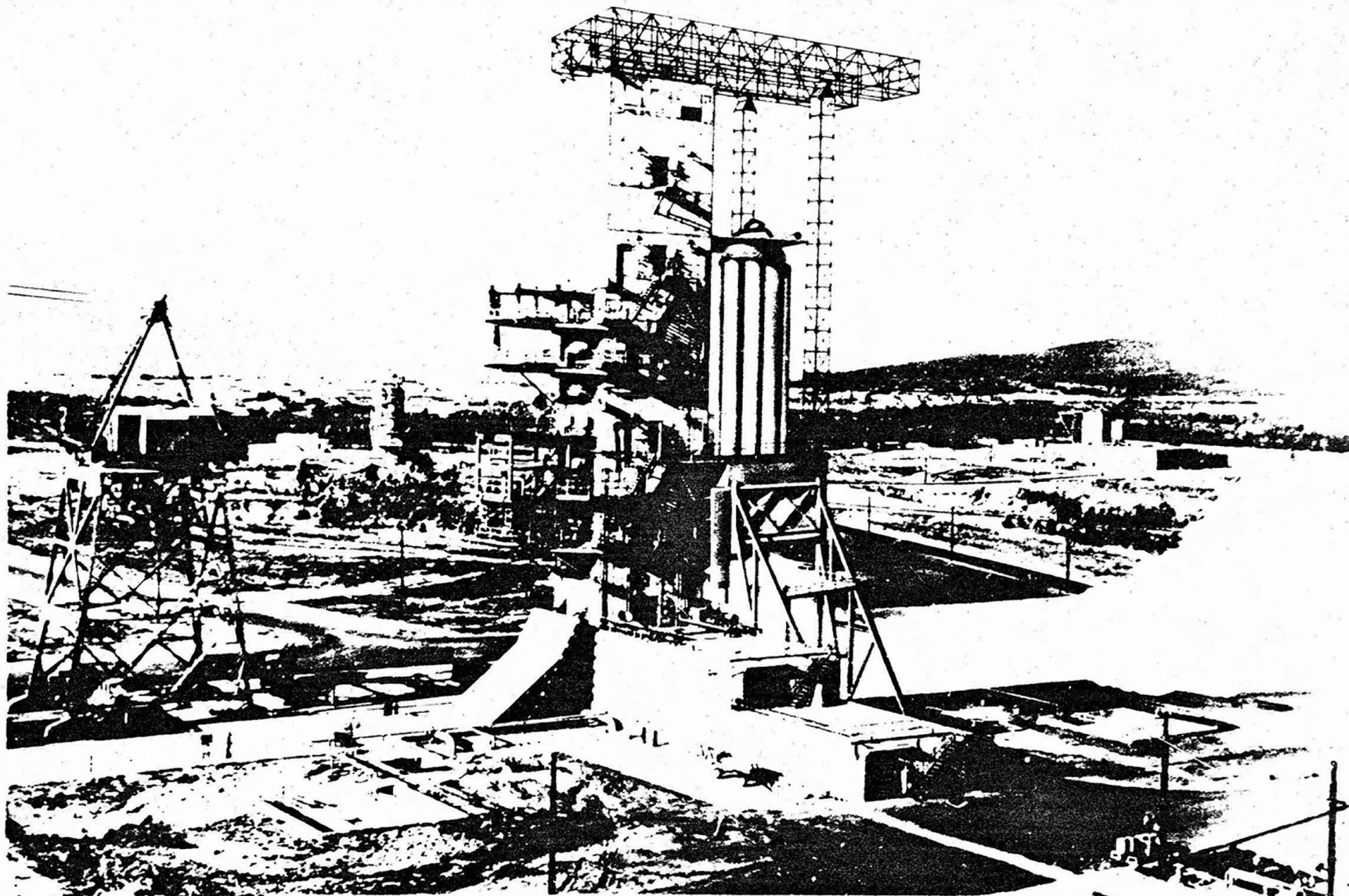

JUNO V BOOSTER ON ABMA TEST STAND

~~SECRET~~

FIGURE 15

of preliminary system evaluation and instrumentation and operation technique verification.

Single engine evaluation tests will be performed as soon as the modified JUPITER (H-1) engine is available. Besides acceptance tests, evaluations of ignition and cut off sequences, pump suction characteristics, engine accessories, gimbaling characteristics, engine instrumentation program, system control networks, vibration characteristics, reliability of components, ground and support equipment, operational procedures, thrust control, and gain factors, will be determined.

Cold flow tests on the entire boosters with water and propellants, will be the initial program conducted on the test stand. The technique of using the turbopumps in a bobtail configuration will be applied; both water and actual propellants will be used. Although time may preclude, it may be feasible to provide a plenum device on the pump outlets to simulate chamber build-up. This would enable the entire cluster to perform under operational conditions without the hazards involved in ignition and mainstage tests.

Following the cold flow program, LOX-water ignition sequence tests will be made, first on individual engines, followed by a group of four and then eight. The next step will be ignition and mainstage firings, starting again with an individual engine and then testing the inboard four, the outboard four, and finally the entire booster.

The test program required to support the JUNO V development program is an accumulation of experience, techniques, facilities, instrumentation, and equipment proven to be the most reliable and productive during past and current activities. It is felt that the above outlined approach will provide the maximum return to the program.

B. Fabrication and Assembly

The problems in the fabrication of the containers for the large clustered booster are not unique in that present fabrication techniques and tooling will be utilized. These techniques and tooling have been tried and proven, thus allowing more time and effort to be applied to the new problems that must be solved in the segmented thrust frame, LOX and fuel manifolds, and such problems associated with the clustering of many power plants into one booster.

In the assembly of the booster there will be many new, challenging problems to be solved. It is proposed that the large booster be broken down into as many large subassemblies as possible so that several crews can be employed at the same time, thus allowing work to progress at a more

uniform rate. These subassemblies will be built up, inspected, and checked out as a single unit, without interrupting work on other subassemblies, after which they will be assembled into the final booster assembly for mating test, systems tests, and pressure tests. The booster then will be disassembled and shipped.

The only new requirements, other than the usual fabrication tooling, will be the large assembly cars, alignment equipment, and handling equipment necessary to perform the final assembly.

C. Launching and Handling Considerations

The proposed vehicle configuration requires a new approach in launching techniques, not only because of its dimensional properties, but mainly because multi-engine vehicles have to be restrained from lift-off until complete ignition and thrust development for all engines has occurred.

Considering the upper stages and the unusual length and weight of the whole vehicle, the support has to be extremely stable and rigid. The support and holddown systems shown in Figs. 16, 17, and 18 are suggested. These systems are considered to be the most practical for both the static and flyable versions.

The vehicle will be supported at four radial holes located 90° apart at the outer circumference of the outer thrust frame. These will be the main supports. Four auxiliary supports will be located at the end frame of the booster also 90° apart but at 45° with respect to the main supports.

In order to assemble the booster on the firing pad in the initial development phase, the following steps are proposed:

(1) Lift the thrust frame-engine assembly by crane and place on the auxiliary supports of the launcher.

(2) Engage the four main support pins by placing them in the respective holes of the outer thrust frame. This establishes a rigid base for the assembly of the tanks.

(3) Lift center tank by crane, using available hoisting equipment and assemble to the vehicle base. Successively assemble the outer tanks, also using the crane and available lifting equipment.

The launcher will be approximately 30 to 35 feet high and will have a hexagonal base of approximately 35 feet. (See Fig. 17.) It will be a tubular

~~SECRET~~

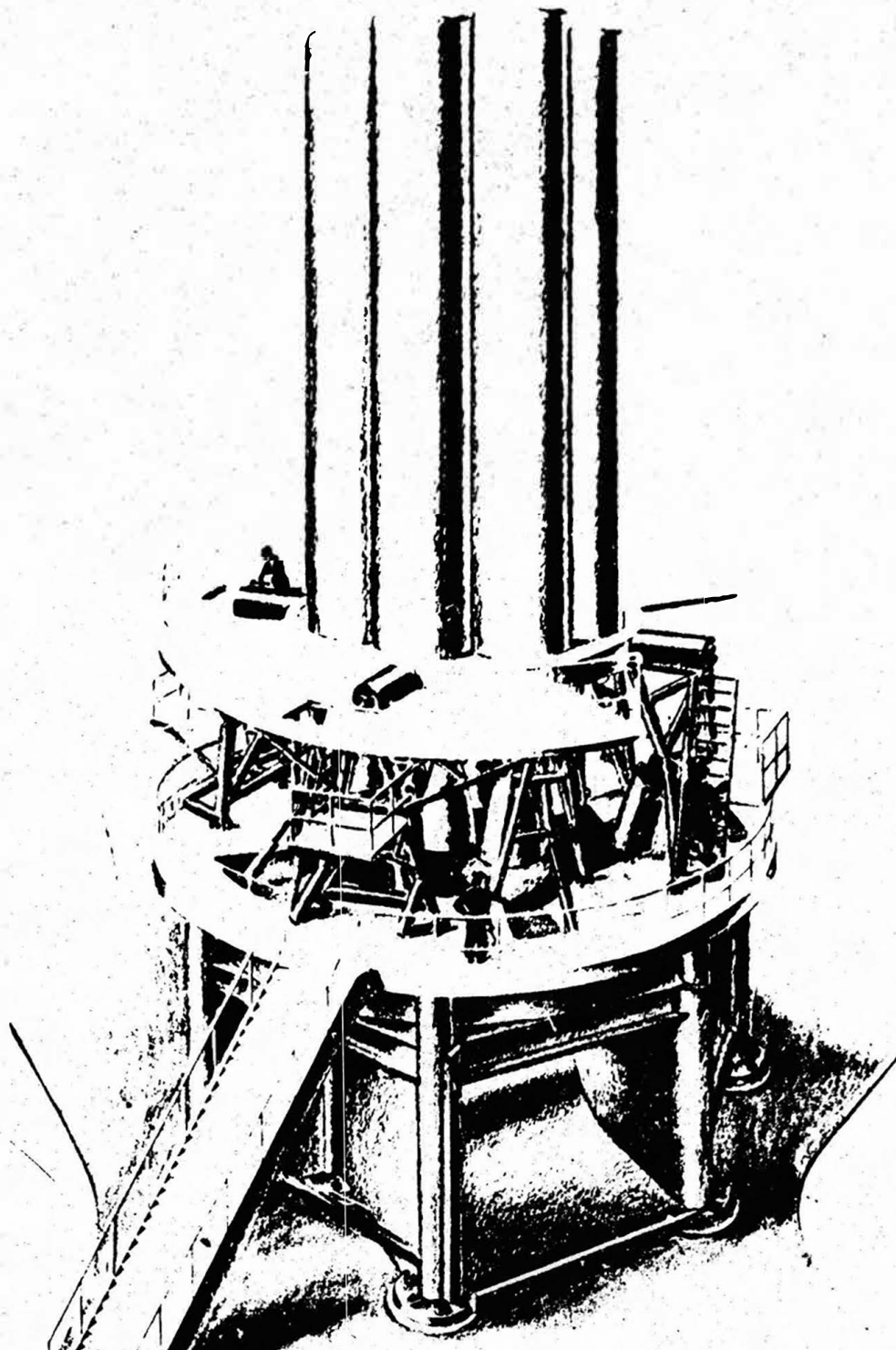

JUNO V ON
LAUNCHING PLATFORM

~~SECRET~~

FIG 16

~~SECRET~~

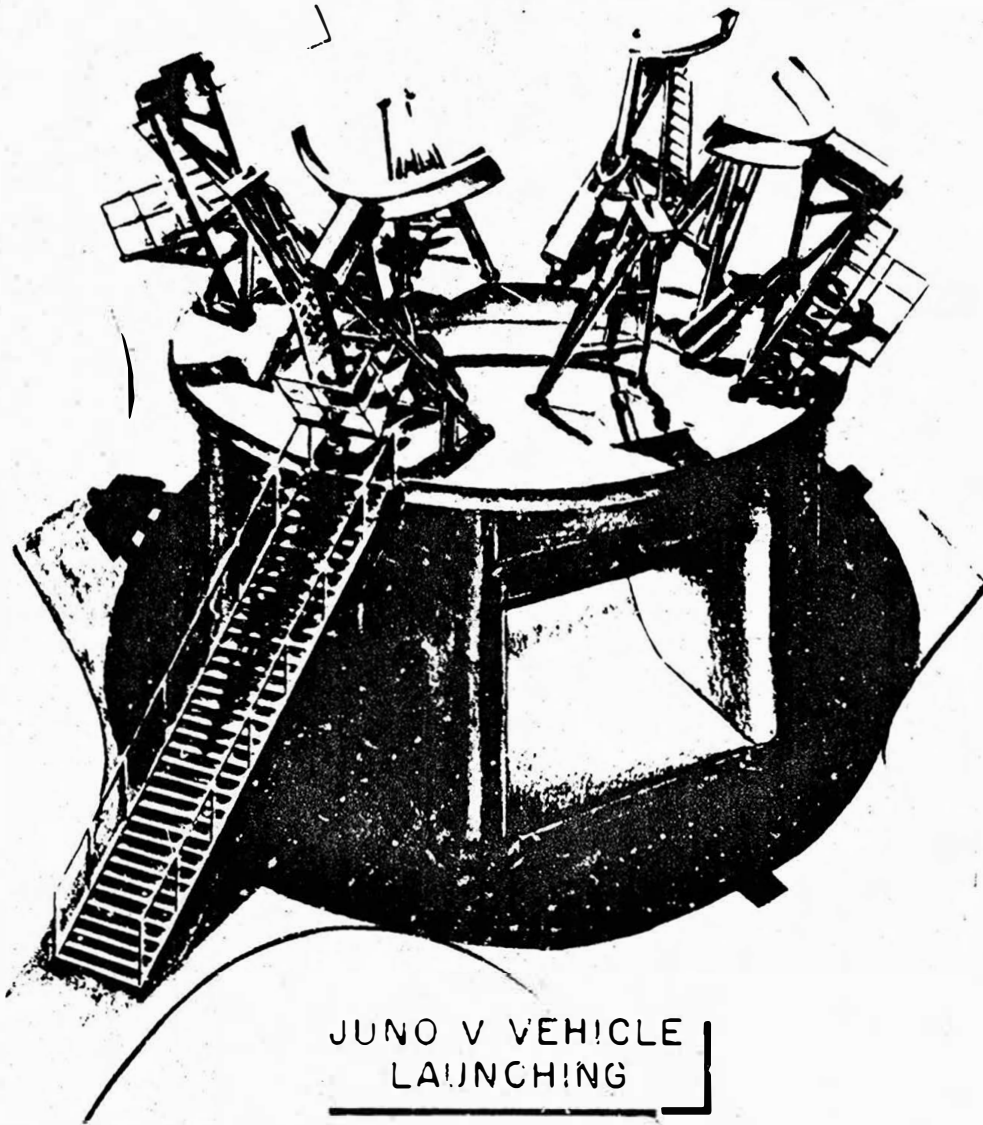

JUNO V VEHICLE
LAUNCHING

~~SECRET~~

FIG 17

FILE NO 655-14 8 OCT 1958

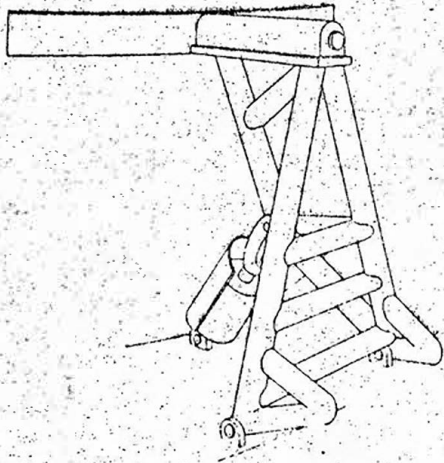

PROPOSAL NO. 1

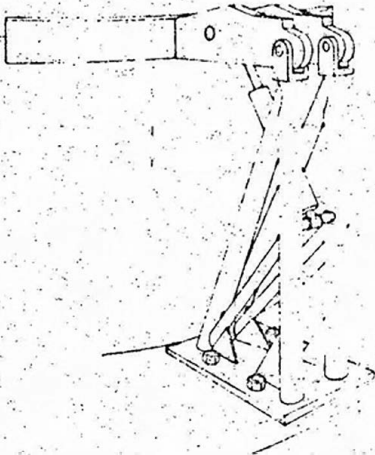
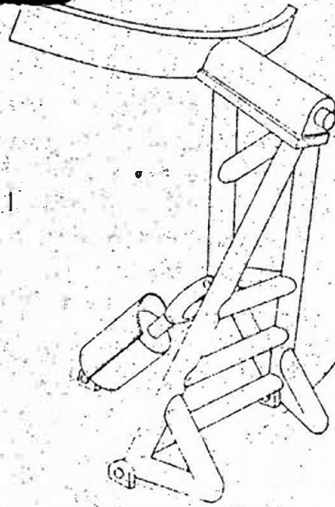

PROPOSAL NO. 2

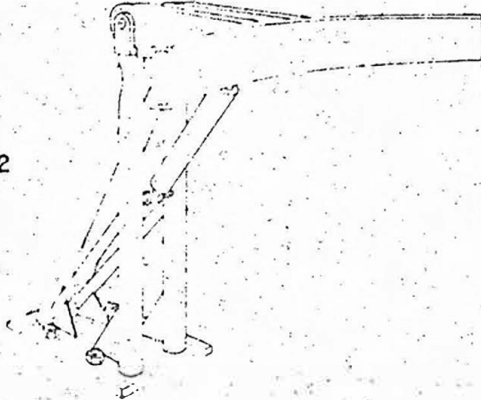

JUNO III BOOSTER
HOLD DOWN DEVICES
FOR LAUNCHING

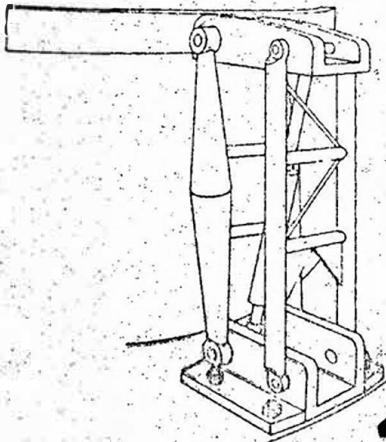

PROPOSAL NO. 3
(SELECTED)

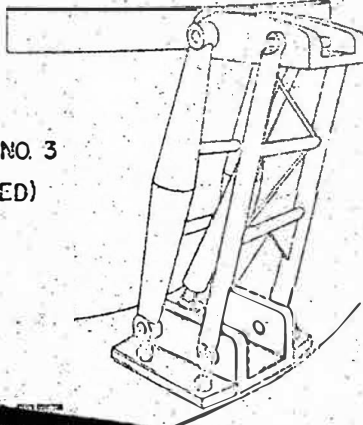

FIG. 18

steel structure with a two-way flame deflector. On top of the hexagonal structure, there will be a turntable allowing for 360° rotation. On the turntable there will be four main and four auxiliary support arms. The main arms support the fueled vehicle and retain it until full combustion is obtained. The release mechanism is a hydro-pneumatic system. The auxiliary arms support the thrust frame and engine assembly during the missile assembly phase. The auxiliary support arms will have a built-in hydraulic jack to apply pressure at the end frame of the assembled empty vehicle in order to check out the launcher release mechanism. Two complete launch emplacements would be desirable for a large-scale R&D flight test program to insure completion of the tests without extensive delays. Water and nitrogen purge systems will be provided and the launcher can be used for captive firings of 2 or 5 sec duration. The advantages of the proposed launch system are summarized as follows:

- (1) Maximum stability because of a self-freeing pneumatic release mechanism.
- (2) Support structure, actuator controls, and accessories are in a naturally protected position.
- (3) Maximum accessibility of engines and firing accessories is provided.
- (4) Minimum damage possibility during firing. The flame deflector is relatively easy to exchange.

The transport scheme for the first-stage booster of the JUNO V vehicle will utilize the tactical designed JUPITER and REDSTONE transporters by either land or air from the fabrication area to the launch site by dismantling the clustered tankage into individual components. Since no individual components will exceed cross-sectional dimensions of 10 x 10 ft and the weight limitation of 25,000 lb, which are requirements for aircraft, rail, and highway shipment, the design is consistent with similar JUPITER and REDSTONE transporters being utilized. Existing transporters, therefore, could be used without major modification. At the launch site, the transporter with tankage can be unloaded by conventional hoisting devices and arranged into a composite first stage on the launcher.

Hoisting and erecting of the segmented engine thrust frame, the composite tankage of the first stage, and the completed second and third stages on the launcher, can be accomplished with a 25-ton gantry crane. (See Fig. 19.) The heaviest anticipated load can be lifted by the hook on the main 100-foot boom. The height required for staging erection is facilitated by booming back the main boom until the 40-foot jib boom is over the working radius. Due to the

~~SECRET~~

ERECTION OF JUNG II
INTERIM TEST VEHICLE
ON LAUNCHER

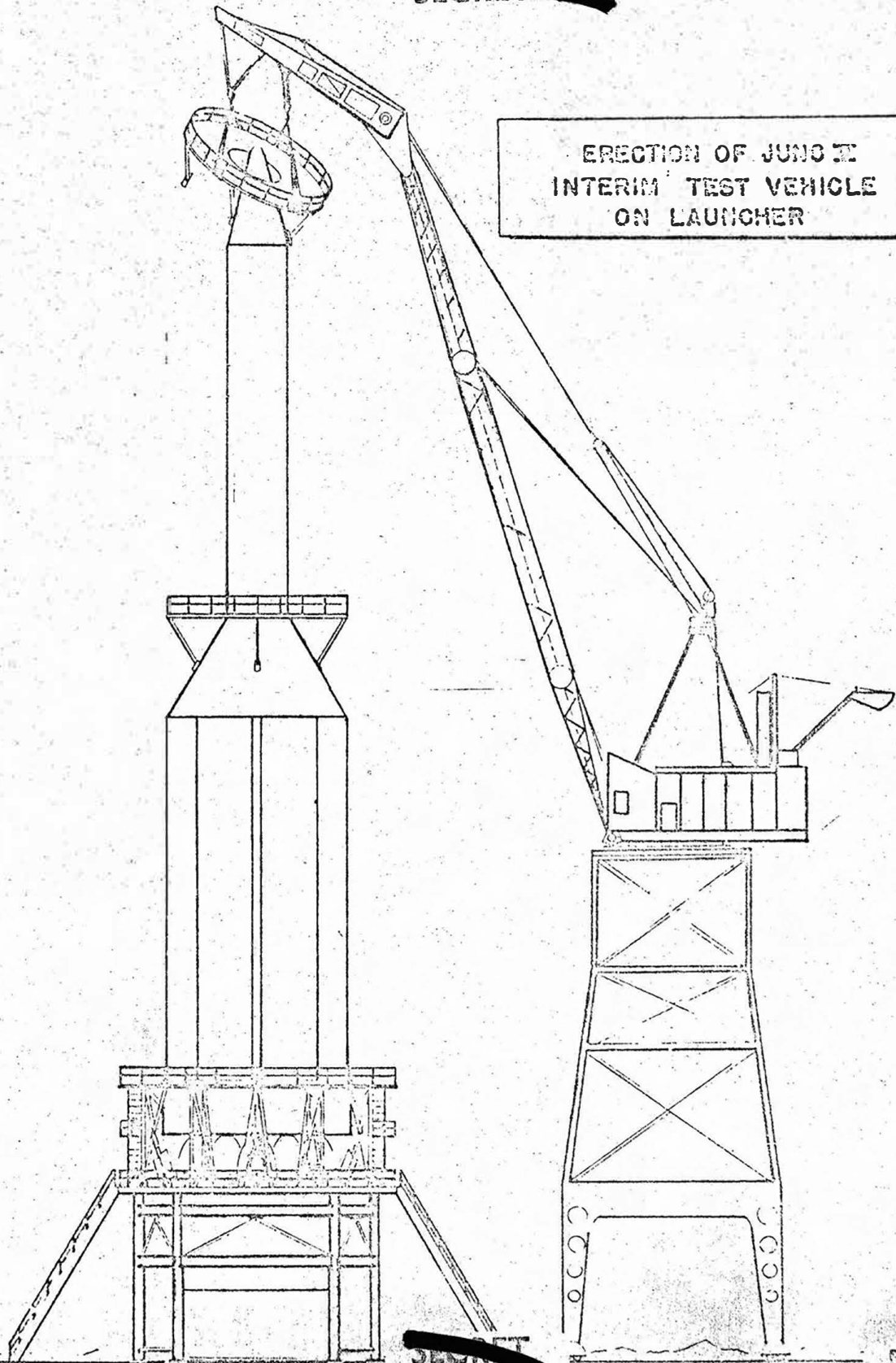

~~SECRET~~

FIG. 17

size and height of the vehicle, it can be considered a stable column to which the servicing platform can be attached, at the required working levels. The crane will be used in the assembly and dismantling of the service platforms surrounding the vehicle. (See Fig. 19.)

D. Launching Facilities

The site and launch facilities should be planned and built for the firing of the clustered first stage only, but should have inherent expansion capabilities to accommodate a full three- or even four-stage version. Since development of this launch site should utilize existing plant facilities and utilities wherever possible, a Cape Canaveral site was the only consideration. The resulting firing azimuths will probably be between 45 and 100 degrees east of true north.

The launch facilities will be designed for approximately a 2,000,000-lb reaction force, and will provide for preflight functional live engine tests up to five-second duration. The required beneficial occupancy date for the launching site is June 1960.

The TNT equivalent rule for ground safety (hazard considerations should be based on 50 per cent of total weight of liquid propellant as being equivalent in releasable energy to that amount of TNT) will be used in the design and, applying this rule, the preselected radius of the ground safety zone is 5410 feet. This safety zone should be enforceable from X-30 minutes until firing during the initial firing and launch phase.

Five promising sites at Cape Canaveral have been considered and are listed below with their costs. These costs are preliminary and are given for comparison purposes only.

1A. New launch pad just north of VLF-20; a TITAN site on which construction has been stopped. The existing TITAN blockhouse could be used (\$4,198,000).

1B. Modified VLF-20 for JUNO V vehicle use. Here again the TITAN blockhouse could be used (\$3,953,000).

2. New launch pad southeast of VLF-11; an ATLAS site using the existing blockhouse (\$4,033,000).

3. New launch pad east of VLF-56; a JUPITER site, using the existing JUPITER blockhouse (\$4,488,000).

4. New launch pad and blockhouse northeast and clear of VLF-20, TITAN site (\$5,418,000).

Proposals (1A) and (2) are simpler in nature, more readily effected, and less complex than proposals (1B), (3), and (4). Construction being terminated on VLF-20 before occupancy of project TITAN, permits blockhouse technical equipment installations to be effected without excessive movement of installed equipment as would be necessary in proposals (2) and (3). Although utility services are available under proposals (1A), (1B), (2), and (3), requiring only extension from existing facility to adjacent proposed new launch pad, extensive modifications and new services to existing VLF-56 utilities would be necessary to permit proposal (3) to be accomplished. Extensive modification would be necessary to VLF-20 to accomplish proposal (1B), rendering utility of VLF-20 impractical for future TITAN usage without remodification. Proposal (4) would require complete utility development in a new area. Necessary lead times for effecting these proposals are:

Proposal (1A)	22 months
Proposal (1B)	21 months
Proposal (2)	22 months
Proposal (3)	21 months
Proposal (4)	26 months

General construction methods usually employed would interfere with missile test operations under proposals (2) and (3); conversely, scheduled missile test operations in VLF-11 and VLF-56 would cause interruptions and difficulties to construction contracts operating adjacent or in these two areas. Proposals (1A), (1B), and (4) can be effected without such interferences. Proposal (3) could not be effected without considerable interference from firing schedules of ABMA on VLF-56, VLF-26, and VLF-30. Also, considerable interference would be occasioned by other scheduled operations of THOR and POLARIS on VLF-17 and VLF-25. Excepting proposal (4), cross interference to scheduled operations of JUNO V is minimal only for proposal (1A); under proposals (1B), (2), and (3), density of cross interference during test operations would be untenable to maintaining required schedule for the JUNO V program.

The launch pad should be reinforced concrete, 230 feet in diameter, with blast resistant area 160 feet in diameter; with center mounting launch table and deflectors; with surface level rail tracks for movement of service structure; with subsurface instrumentation terminal room, fuel and LOX tanks; with surface generator building, transformer vault, and camera pads;

with necessary personnel accessways and cableways. The launch pad is to be provided with fire fighting deluge and flame coolant water supply and to be sloped to carry off fuel dilution water.

The blockhouse is to be of reinforced concrete design, positioned 1050 feet minimum distance from the launch pad with means for optical observation of operations on the launch pad. Also, it must be adequate for the missile test and launch console, instrumentation racks, remote-control fueling and high-pressure air panels, and operating personnel. Complete hazard protection of personnel is required and necessary; air conditioning, for equipment heat removal and for personnel, must be provided with adequate flushing and ventilation means for buttoned-up operation in case of a missile failure. Estimated number of personnel stationed in blockhouse for operation is 130 persons including observers. The existing TITAN blockhouse, or a blockhouse similar to the planned PERSHING facility, would be acceptable.

The LOX and fuel supply system will consist of one 100,000-gallon tank (LOX) and one 60,000-gallon tank (fuel) with pumps, valves, and accessories located behind revetments spaced to meet applicable safety distance requirement from launch pad.

A water supply for fire fighting, pad flushing, and coolant will be required. The coolant supply may be utilized for flushing and fire fighting requirements.

Of the proposals considered, proposal (4) is excluded on the basis that the cost is the highest, the time of availability is not commensurate with the requirement, and that the area in which it is proposed is not yet developed for industrial use. Cross interferences, during construction, to ABMA test operations, and to other missile projects such as THOR, POLARIS, etc., seem to preclude installation of this facility under plan (3). Under proposals (1B) and (2), construction and occupancy would necessitate removal of equipment essential to ATLAS and TITAN operations which would have to be replaced to permit operation of these projects either during or after execution of JUNO V project. Under proposal (1B), either the TITAN launch structure or the proposed launch structure for JUNO V would be affected. Under proposal (2), instrumentation installed in the ATLAS blockhouse would have to be removed for JUNO V and reinstalled for ATLAS operations. If proposal (2) were utilized, cross interference between JUNO V and the ATLAS would result in excessive loss of time for both projects due to overlap of ground safety areas, etc.

Of all the sites considered, proposal (1A) is most convenient (see Fig. 20) to ABMA-MFL assembly area at CCMTA for the planned

~~SECRET~~

RECOMMENDED JUNO II LAUNCHING SITE

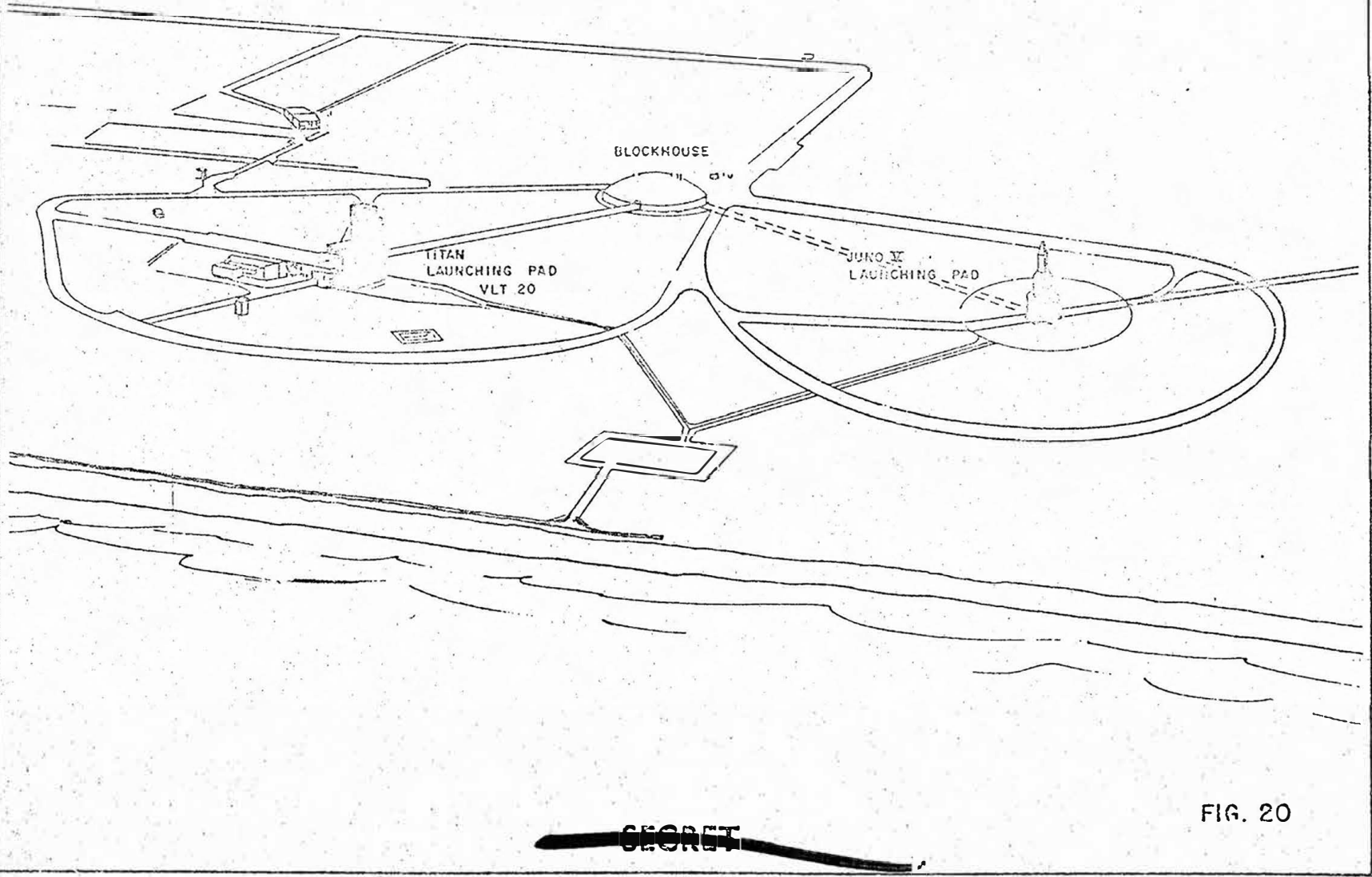

56

~~SECRET~~

operation; construction at this site can be effected with minimal amount of cross interference; no facilities are affected that would be completely removed from present or future duty; the installation of instrumentation and technical equipment in the blockhouse can be made without affecting another project; and the estimated cost for the recommended launching facilities is well within funds anticipated for this part of the project.

SECRET

VII. SCHEDULE

The schedules presented are divided into two phases: (A) Captive Firing of the Booster, and (B) Flight Test Program of the JUNO V.

A. Captive Firing of JUNO V Booster

As shown in Fig. 21, the schedule for the captive firing phase of the booster program has been divided into four areas: (1) Design and Engineering, (2) Fabrication and Assembly, (3) Checkout and Test, and (4) Captive Firing. As indicated on the schedule, the first engine delivered will be utilized on a single engine test setup for engine familiarization and reliability tests. These tests will include both hot and cold, as well as short and long duration, runs during the five-month single engine test program.

The captive testing of the booster will be divided into three steps. In order to approach the complete vehicle configuration in steps, a test program of running the four inboard engines alone, then the four outboard engines alone, has been adapted before going to the firing of the entire eight engines.

The availability of components required to meet the schedule presented on the captive firing phase of the program has been verified with the respective organizations involved and long lead-time items such as engines are presently covered contractually. Engineering designs and studies on the booster, test-stand modifications, and detailed planning in all areas of the captive firing demonstration are proceeding as indicated.

The manpower requirements to accomplish the captive firing of the booster by December 1959 is well within the capability of ABMA.

B. JUNO V Flight Test Program

The schedule shown in Fig. 22 outlines the flight test program for a total of four JUNO V vehicles. As indicated in the flight test schedule, the first two vehicles (No. 1 and No. 2) will be fired as booster test vehicles only, with booster recovery, and vehicles No. 3 and No. 4 will be fired as two-stage interim test vehicles with orbital capability, but no recovery of the first stage. The first flight of the booster vehicle, No. 1, will be made utilizing the captive test tankage with a new set of engines. It is anticipated that the original set of engines ordered for captive testing will be run extensively during the program and will not be acceptable for flight due to total accumulated burning time. The original set of engines will, however, be reworked and utilized on later flight vehicles or for single-engine development and product-improvement testing.

SCHEDULE
CAPTIVE FIRING OF JUNO V BOOSTER

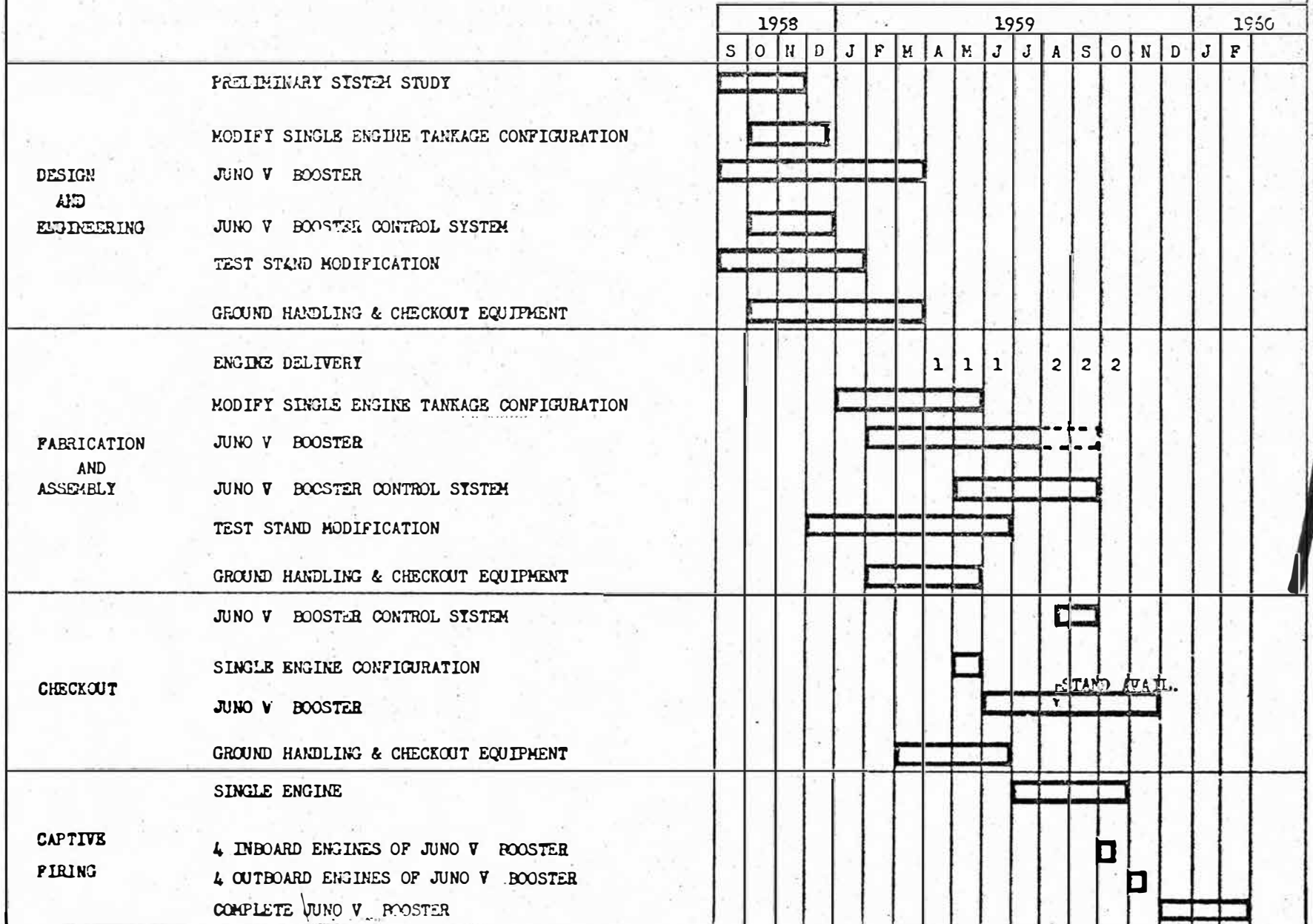

59

FIG. 21

SECRET

SECRET



~~SECRET~~

JUNO V FLIGHT TEST PROGRAM SCHEDULE

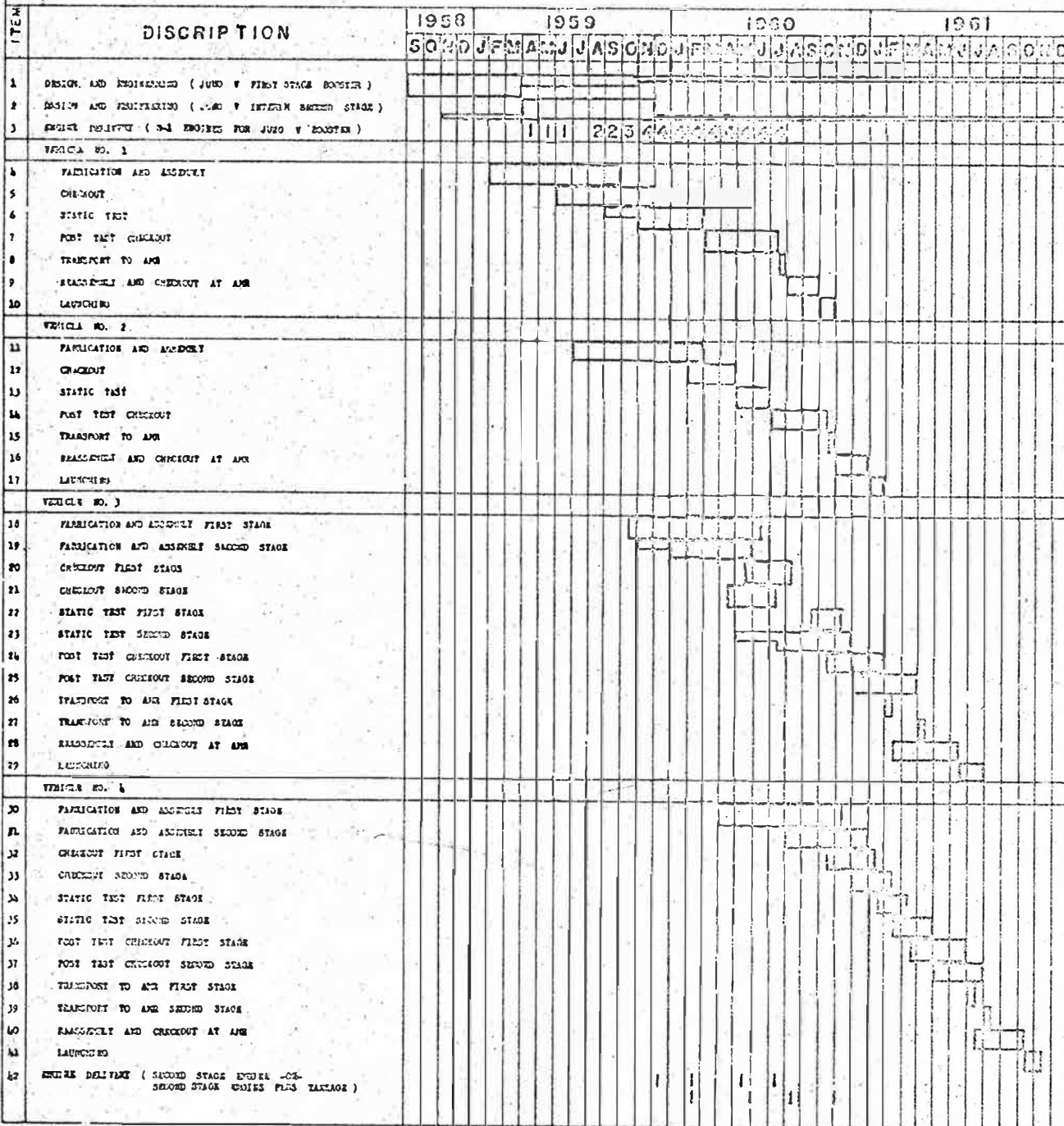

~~SECRET~~

FIG. 22

The following booster vehicles, No. 2, 3, and 4, will involve the procurement and fabrication of three complete systems as flight-test vehicles only. Due to the time limitation in static firing checkout, it is anticipated that very little if any testing will be accomplished as pure engine development on the clustered configuration tankage.

The JUNO V flight test schedule is considered to be obtainable within the present capabilities of ABMA; however, two critical items which could cause a schedule delay require immediate attention:

1. Engine delivery, Item 3 on Fig. 21, has been covered contractually for the first nine engines and long-lead items for the eight additional engines to be used for vehicle No. 1 flight test. Due to the long-lead time required for engine hardware, it will be necessary that immediate action be taken to insure delivery as indicated for the remainder of the engines. Present plans are to procure all engines, including the captive test engines, on an incremental funding basis to alleviate the requirement of complete funding at time the engines are ordered.

2. Although no decision has been made as to which of several possible second stages will be used for vehicles 3 and 4, it is necessary that action be taken to provide funding to accomplish engineering, fabrication, and testing of the second-stage system. As can be seen on the schedule, engineering should begin the latter part of 1958 and be completed not later than November 1959. It will also be necessary to procure long lead-time items for the second stage early in 1959 to insure delivery of hardware to meet the proposed schedule. Item 42 on Fig. 22 indicates delivery dates of engines, or propulsion units, as required for the second stage to meet the proposed schedule.

VIII. SUMMARY

In summarizing the JUNO V development program, the present progress should be made known.

After a careful comparison of the available engines in the 150K thrust class, the NAA H-1 engine was selected as the basic component of the cluster. This engine, rated at 138K, is a greatly simplified S-3D engine and is compatible with the required time schedule.

Arrangement studies resulted in the eight-engine configuration which has been described. This gives a total, sea-level thrust of 1504K. One set of booster engines has been ordered and delivery will begin in April 1959. Promising booster propellant flow designs are currently being studied.

The parallel tankage arrangement consisting of a 105-inch central tank plus an outer ring of eight 70-inch tanks was chosen as the basic structure for reasons of economy, air transportability, and scheduling. A detail design of the booster tanks, their supporting structure, and the engine thrust frame are now in progress. A simple parachute recovery system, made up of existing components, will be used for the first two non-orbital flights.

Basic studies in the guidance and control area show that the requirements are compatible with components available from the JUPITER and PERSHING programs. Initial control design has been started. The first four vehicles will carry a complete guidance and control system and extensive instrumentation. Command cutoff is planned for the first two flights and depletion cutoff for the two orbital flights.

The design of the required modification to the ABMA test tower has been frozen and work should begin in November 1958. Handling equipment requirements are in the study and design phase. Design of a new launching pad and the changes needed in the TITAN blockhouse near VLF-20 at the Atlantic Missile Range are in progress. Cost of the required pad and modifications is estimated at \$4.2 million.

Various possibilities of obtaining an orbital capability early in the flight test program with a two-stage vehicle are presently being studied. The use of a modified JUPITER is one of the most promising solutions because of the availability of hardware, tooling, ground equipment, system familiarity, and its good payload characteristics. Gross payloads up to 10,000 pounds, for a 300-mile altitude, can be expected from such a vehicle.

Based on proposed funding, the highlights of the JUNO V development program can be summarized as follows:

Captive dynamic demonstration of booster - December 1959

Flight test of vehicle No. 1 (booster and dummy top section, non-orbital) - September-October 1960

Flight test of vehicle No. 2 (booster and dummy top section, non-orbital) - January 1961

Flight test of vehicle No. 3 (booster and second stage, orbital capability) - June-July 1961

Flight test of vehicle No. 4 (booster and second stage, orbital capability) - October-November 1961

IX. CONCLUSIONS AND RECOMMENDATIONS

A. Conclusions

As a result of a detailed study of the JUNO V space vehicle development program requirements the following conclusions can be drawn:

(1) Schedule requirements, cost limitations, and engineering considerations favor the selection of a NAA engine cluster with a nominal thrust of 8 x 188K for the propulsion system combined with a parallel tankage arrangement. This design approach appears to be near optimum as seen today and makes maximum use of existing production and test facilities.

(2) The present anticipated 72 million dollar - four vehicle - program is adequate to demonstrate the usefulness of a 1.5 million-lb thrust booster for the launching of large orbital payloads. It should not, however, be considered as an R&D program designed to fully exploit the potentialities of such a development nor can it produce the required final reliability.

(3) The anticipated firing schedule, which includes the launching of two 2-stage vehicles with orbital capabilities, requires a decision within 3 months on the second stage to be used. Funds up to \$5.96 million of FY 1959 and 1960 money will be required depending on the type of second stage selected.

(4) If an uninterrupted continuation of the flight test program is desired after the present four-vehicle program, additional funding of a small amount will be required in FY 1960 and of a larger amount in FY 1961 for long lead-time items.

(5) The modification of the test tower and construction of the proposed interim launching site will have to be initiated without delay if the desired free flight firing schedule is to be met.

(6) A booster recovery program, beginning with a simple parachute system, is considered mandatory to improve overall system reliability and reduce long-term total funding requirements for the JUNO V space vehicle.

(7) The 2-stage JUNO V orbital carrier vehicle will provide the first U. S. capability for launching a 10,000-lb gross payload into orbit by mid 1961.

(8) The 3-stage JUNO V vehicle will provide the first U. S. capability for launching a satellite in the 20,000 to 30,000-lb class in 1962 and could provide the first manned lunar circumnavigation by 1963/1964 if an all-out program could be initiated in 1959.

B. Recommendations

In concurrence with the above conclusions the following recommendations are made:

(1) Authorize supporting study of system requirements for the JUNO V space vehicle within the National Space Flight program which does not require additional funds. This study should include various possibilities of total multi-stage vehicle configurations and capabilities with emphasis on (a) reliability, (b) economy, (c) performance. Such information is anticipated since a compilation of facts should be available by summer 1959. This compilation will serve as a basis for further decisions by ARPA on the continuation of the development program.

(2) Expand presently envisioned feasibility demonstration program covering four vehicles into an all-out R&D program not later than summer 1959 to keep abreast with, or possibly surpass, the RUSSIAN capabilities in this area. In this respect action should be taken in the near future to make additional funds available for the procurement of long lead-time items for the program, beyond the four approved vehicles, to insure an flight test program in 1962 and 1963.

(3) Approve and support the development of booster recovery techniques beginning with the first two flight tests of the JUNO V booster. Booster recovery is considered mandatory for a economically feasible long-range program. This will not require additional funds within the four-vehicle program.

(4) Two-stage orbital test vehicle should be assigned a reentry test payload for assisting development of payload and capsule recovery. Payload as well as second stage must be funded separately.

(5) Initiate steps for construction of operational equatorial launching site to be available by summer 1962.

SIGNATURES AND APPROVAL, DSP-TM-10-58

H. H. Kocile

H. H. Kocile

F. L. Williams

F. L. Williams

W. G. Huber

W. G. Huber

R. C. Callaway, Jr.

R. C. Callaway, Jr.

APPROVED:

W. A. Mrazek

W. A. MRAZEK

Director, Structures and Mechanics Laboratory

Wernher von Braun

WERNHER VON BRAUN

Director, Development Operations Division

DISTRIBUTION LIST

- ORDAB-X Commander
- C Chief, Control Office (10)
- D Dr. von Braun
- D Mr. Rees
- D Mr. Dannenberg
- D Mr. Rudolph
- D Mr. Saurma
- D Mr. Constan
- DA (9)
- DC (12)
- DF (12)
- DG (44)
- DL (30)
- DM (27)
- DV (9)
- DR (28)
- DT (24)
- DS (2)
- DSR
- DSD (8)
- DSF (6)
- DSN (7)
- DSP (10)
- DST
- DSC
- HSI (8)
- DIR

(Additional copies are available through ORDAB-DSP, extension 4714.)

REFERENCES AND BIBLIOGRAPHY

A. References

1. Economic Aspects of Booster Recovery (U), DSP-TM-6-58, Army Ballistic Missile Agency, Redstone Arsenal, Alabama, 1 August 1958, Secret.

2. Initial Findings of Work on Navy Solid-Fuel Propulsion Test Vehicle (U), MSD-1691, Lockheed Missile Systems Division, Van Nuys, California, 10 May 1956, Confidential.

3. Altitude of Minimum Orbital Payload (U), DSP-TR-1-58, Army Ballistic Missile Agency, Redstone Arsenal, Alabama, 8 September 1958, Unclassified.

B. Bibliography

1. Orbital Rockets, Journal of British Interplanetary Society, K. W. Gatland, A. M. Kunesch, and A. E. Dixon, Vol. 10, No. 3, p. 97, (1951).

2. Die Optimale Lastrakete zur Aussenstation in 1669 km Hohe (The Optimum Cargo Rocket to a Satellite at 1669 km Altitude), H. Hoepfner and H. H. Koelle, Gesellschaft fur Weltraumforschung Research Rpt. No. 7, (1951).

3. Establishment of Large Satellites by Means of Small Orbital Carriers, K. A. Ehrlicke, Proceedings, III International Astronautical Congress, Stuttgart, p. 111, (1952).

4. Die Satellitenrakete 1952 (The Satellite-Rocket 1952), H. Hoepfner, Proceedings, III International Astronautical Congress, Stuttgart, p. 97, (1952).

5. Fabrication of the Orbital Vehicle, A. E. Dixon, K. W. Gatland, and A. M. Kunesch, Proceedings, IV International Astronautical Congress, Zurich, p. 125, (1953).

6. Das Marsprojekt (The Mars Project) (U), W. von Braun, University of Illinois Press, 1953, Unclassified.

7. Fabrication of the Orbital Vehicle, K. W. Gatland, A. M. Kunesch, and A. E. Dixon, Journal of British Interplanetary Society, Vol. 12, No. 6, p. 274, (1953).

8. A New Supply System for Satellite Orbits, K. A. Ehrlicke, Jet Propulsion, Vol. 24, No. 5, p. 302, (1954).

9. Preliminary Engineering Study of a Satellite Station Concept Affording Immediate Service with Simultaneous Steady Evolution and Growth, D. C. Romick, American Rocket Society Preprint No. 274-55, p. 17 (1955).

10. A Preliminary Design Investigation of a Minimum Sized Ferry Rocket Vehicle of the Meteor Concept, D. C. Romick, R. E. Knight, and S. Black, Proceedings, VIII International Astronautical Congress, Barcelona (1957).

11. E-1 Rocket Engine Development Program (C), Report No. R-779P, Rocketdyne, Canoga Park, California, 10 January 1957, Confidential.

12. E-1 Thrust Chamber Cluster Configuration for Booster Systems (U), Rocketdyne Ltr PD57-321, 21 August 1957, Confidential.

13. Thermal Properties of Several Gas Generator Propellants (U), Rocketdyne Ltr PD57-336, 27 August 1957, Confidential.

14. Estimated Poise Field Surrounding a 1,520,000 lb Rocket Engine (U), Rocketdyne Ltr PDM 57-122, 10 October 1957, Confidential.

15. E-1 Turbine Exhaust System Performance (U), Rocketdyne Ltr PDM 57-95, 23 October 1957; Confidential.

16. Gas Generator System for Four E-1 Engines (U), Rocketdyne Ltr PDM 57-109, 30 October 1957, Confidential.

17. SIS Performance Data (Part I) (U), DA-TN-54, Army Ballistic Missile Agency, Redstone Arsenal, Alabama, 8 November 1957, Secret.

18. SIS Performance Data (Part II) (U), DA-TN-55, Army Ballistic Missile Agency, Redstone Arsenal, Alabama, 14 November 1957, Secret.

19. A National Integrated Missile and Space Vehicle Development Program (U), D-R-37, Army Ballistic Missile Agency, Redstone Arsenal, Alabama, 10 December 1957, Secret.

20. Thrust Vector Misalignment and Thrust Variation Effects in a Clustered Booster Engine (U), Rocketdyne Ltr PD58-121, 14 March 1958, Confidential.

~~SECRET~~

21. Altitude Control in a Clustered Booster Engine by Engine Thrust Throttling (U), Rocketdyne Ltr PD58-120, 12 March 1958, Confidential.

22. Preliminary Proposal for a Space Defense System (U), U. S. Army Ordnance Missile Command, Redstone Arsenal, Alabama, 10 July 1958, Secret.

~~SECRET~~

~~CONFIDENTIAL~~

Appendix A

MEMORANDUM OF AGREEMENT - Advanced Research Projects Agency
and Army Ordnance Missile Command

SUBJECT: High Thrust Booster Program Using Clustered Engines

On 15 August 1958 ARPA, by Order No. 14-59, directed AOMC to initiate a development program to provide a large space vehicle booster of approximately 1.5 million pounds thrust based on a cluster of available rocket engines, with the immediate goal of demonstrating a full scale captive dynamic firing by the end of Calendar Year 1959. The purpose of this Memorandum of Agreement is to further delineate the objectives of this program, specifically including projected FY 59 and FY 60 funding levels.

In addition to the captive dynamic firing listed above, it is hereby agreed that this program should now be extended to provide for a propulsion flight test of this booster by approximately September 1960. Also, in order to provide for an orderly development leading to increased reliability and actual utilization for placing payloads in orbit, it is desirable that this first propulsion flight test in September 1960 be followed closely by another propulsion flight test and later by two additional booster flights which, without sophisticated upper stages, would be capable of placing limited payloads in orbit.

It is our understanding that the design, development, fabrication, and testing to include the captive dynamic firing and the first flight test described above with require \$13.4 million in FY 59 and \$20.3 million in FY 60. In addition, facility requirements necessary for the accomplishment of the above program are \$1.6 million in FY 59 and \$7.0 million in FY 60.

To support the three additional flight tests described above (one propulsion test flight and two flights carrying orbital payloads), additional FY 60 funds in the amount of \$10.0 million must be provided for the procurement of long lead time items. The engineering, fabrication, static test and launching of these three vehicles (exclusive of payloads and upper stages), would require an estimated \$15.0 to \$20.0 million in FY 61.

AOMC will submit to ARPA not later than 15 October 1958 a detailed development and funding plan based on this agreement. Upon approval of this plan, additional FY 59 funding will be provided.

Signed by J. B. Medaris, Maj. Gen., USA, and Roy W. Johnson,
Director, ARPA, 23 September 1958.

~~CONFIDENTIAL~~

ADMA DSP-24-10-58

Army Ballistic Missile Agency, Structures
and Mechanics Laboratory

JUNO V SPACE VEHICLE DEVELOPMENT PROGRAM
(PHASE I): BOOSTER FEASIBILITY DEMON-
STRATION

13 Oct 58, 71p

SECRET REPORT

Koelle, H. H.

Williams, F. L.

Ruber, W. G.

June 1

Satellite - vehicles--

Design

Satellite vehicles--

Development

The initial phase of the JUNO V space vehicle development program provides for a static demonstration and a total of four flight feasibility tests. This report gives the design philosophy used as well as a description of the booster and the interim two-stage test vehicle which will be used for flights number 3 and 4. Preliminary details of possible upper stage configurations, weight breakdowns, and performance characteristics are presented. Operational aspects such as static test requirements, handling, and transportation considerations, fabrication procedures and launching site requirements are discussed in detail.